



DATA CENTER

INTEGRATED SOLUTIONS

POWERED BY EXPERTS



THE GLOBAL SPECIALIST
IN ELECTRICAL AND DIGITAL BUILDING INFRASTRUCTURES

THE LEGRAND GROUP

Powered by experts

The Legrand Group is a global specialist in electrical and digital building infrastructures, with more than half of its activity in the commercial and industrial fields. In response to major market developments, the Group is continuing to strengthen its position in up-and-coming, ambitious markets.

Within a context of increasing globalisation, in which projects are more and more complex, the support of a knowledgeable, reliable partner is essential: it is the real key to success!

Choosing Legrand gives you the assurance of global expertise thanks to:

- innovative applications and a huge range of products enabling you to build solutions then configure systems which incorporate the latest technological advances
- generalist (Legrand, Bticino...) and specialised (Minkels, Cablofil, Zucchini, Estap, Alpes Technologies...) brands who will help you set up your project, from its design through to its final implementation

80 subsidiaries and offices,
sales in close to 180 countries

36,000
staff members throughout the world

€ 4.5 billion
net sales in 2013



LEGRAND AND SUSTAINABLE DEVELOPMENT

For many years, Legrand has been committed, with its customers and partners, to a process of continuous improvement to ensure profitable, long-term and responsible growth for its business. The Group thus intends to respond to the environmental, economic and social issues of today and the future.

1. A global approach for sustainable development

Legrand's sustainable development approach covers three areas: social responsibility, the environment and governance.

To find out more, visit www.legrand.com

2. Reducing the environmental impact of the Group's sites

Since 1996, Legrand has integrated management and protection of the environment into the way in which it operates its industrial sites.

3. Controlling the use of chemical substances

When manufacturing its products, the Legrand Group systematically seeks out technical solutions to substitute the use of hazardous products.

4. Eco-friendly products

Legrand implements an ecodesign approach to limit the global impact that products have on the environment throughout their entire life cycle.



Corporate Social Responsibility

Voluntary initiatives such as signing up to the Global Compact or meeting the stringent social and environmental criteria of the FTSE4Good and the DJSI* indexes form part of an overall policy of transparency highlighting Legrand's determined commitment to Corporate Social Responsibility.

* Based on evaluation 2010 and subject to annual re-evaluation

INTRODUCTION

What type of data center?	2
Answers to specific requirements	4

1 EFFICIENCY	6
---------------------	---

2 AVAILABILITY	24
-----------------------	----

3 SCALABILITY	44
----------------------	----

4 SAFETY AND SECURITY	54
------------------------------	----

What type of data

data

More and more data centers are being developed in this, the era of cloud computing.

In the era of cloud computing, the development of data centers keeps growing but the needs change. From the necessity of a complete infrastructure to a secure sharing of facilities at a low cost, the data center fits your actual needs.

LEGRAND IDENTIFIES THREE MAIN CATEGORIES OF DATA CENTERS:

ENTERPRISE

These small data centers meet the needs of small and medium sized companies whose:

- business is simply supported by IT (universities, hospitals, town councils, etc.)
- coverage is regional or possibly national.

The management of this type of data center is still largely handled internally, but is increasingly being outsourced with the onset of cloud computing.



CORPORATE

These are medium to large data centers, used by organisations whose:

- core business is directly connected with the data center (banks, insurance companies, oil companies, etc.)
- coverage is international.

They are generally managed internally, via a dedicated department.



center?

COLOCATION

These are large data centers in which different entities can rent servers or space to install their own equipment. The security level in these data centers is high.

This solution enables data management to be wholly outsourced, with the assurance of optimum continuity of service.

For this type of data center, Legrand can work with you at the project development stage.



Answers to specific



Data centers are sensitive areas which consume a huge amount of energy and have changing requirements. They house servers containing large amounts of data. Ensuring they are flexible, efficient and reliable thus means providing a durable infrastructure which provides high performance under all circumstances.

There are four main objectives for providing an optimum response to the specific issues and requirements of data centers.

requirements



**EFFICIENCY
AVAILABILITY
SCALABILITY
SAFETY AND
SECURITY**

Optimise energy efficiency

Data centers consume a great deal of energy. The aim will therefore be to reduce their carbon footprint. How? By improving the PUE (Power Usage Effectiveness). This is an indicator which defines the energy efficiency of a data center by calculating the ratio of the total energy consumed by the data center as a whole to that actually consumed by the IT systems which the data center operates.

→ [DISCOVER OUR SOLUTIONS IN THE « EFFICIENCY » SECTION](#)

Ensure continuity of service

Maintaining an electrical and digital supply throughout the year as well as cooling the servers ensures availability of reliable energy. There are several availability levels. Depending on the level of availability required by the data center owner for all the equipment and infrastructures, the building will be assigned a Tier, from 1 to 4, which guarantees a certain continuity of supply and service.

→ [DISCOVER OUR SOLUTIONS IN THE « AVAILABILITY » SECTION](#)

Incorporate the need for scalability

It may be necessary to add a UPS or a cooling module, server or switch - a data center has to be able to change, and the infrastructures must do the same in order to support the durability of the data center. This involves in particular using solutions which combine optimisation of space and modularity.

→ [DISCOVER OUR SOLUTIONS IN THE « SCALABILITY » SECTION](#)

Ensure the safety and security of equipment and data

A data center houses strategic data that is essential to the operation of the companies to which that data belongs. Protecting the data and the equipment on which it is located against any intrusions or internal/external events is thus an absolute necessity.

→ [DISCOVER OUR SOLUTIONS IN THE « SAFETY AND SECURITY » SECTION](#)



1 EFFICIENCY

OBJECTIVES:

- Optimise the cooling solutions 10
- Reduce power losses 14
- Make use of performance indicators 18

Context & issues

Data centers consume a great deal of energy: 322 TWh in 2012, i.e. 1.8% of global energy consumption*

ENERGY-INTENSIVE BUILDINGS

For example:

- a typical data center consumes 10 to 100 times more energy per m² than a standard office building
- the consumption of a 10,000 m² data center is the same as that of a town with 50,000 inhabitants
- over 10 years, the operating cost of a data center is the same as its installation cost
- the electricity bill represents 10 to 15% of the operating cost

The building infrastructure currently represents close to half of the total energy consumption.

AN INCREASINGLY LARGE ECOLOGICAL FOOTPRINT

The ecological footprint of data centers is constantly increasing: it is estimated that in the next 10 years there will be 30 times more data (90% of which will not be structured) and significant more servers. At this rate, energy requirements could double within 5 years.

Reducing the carbon footprint (one of the main concerns of stakeholders) and improving the energy efficiency of data centers is therefore vital in order to reduce consumption and costs.

BUILDING INFRASTRUCTURE
48 %

IT EQUIPMENT
52 %

Cooling
32 %

Peripherals
(lighting, CCTV,
heating generator)
6 %

UPS, energy conversion
and PDU
10 %

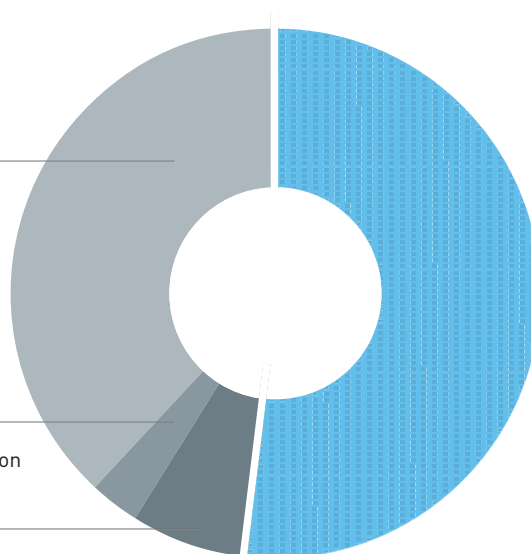

* Source: DataCenterDynamics

Legrand's response

OBJECTIVE: REDUCE THE PUE

The PUE (Power Usage Effectiveness) is an indicator for measuring the energy efficiency of a data center by working out the ratio of the total consumption of the data center to that of the computer and telecoms (IT) equipment. The Green Grid, an international consortium set up to improve the efficiency of data center resources, has defined several PUE levels:

■ Level 0 PUE

This measurement compares the amount of electricity entering the data center with the amount of power consumed by the IT equipment. The new definition specifies that the measurements must be taken during consumption peaks, and behind the UPS. Even if the measurements are increased to regular intervals, an energy efficiency ratio at maximum load is obtained, which is not very representative of the activity of the company.

■ Basic PUE (level 1)

This measurement includes the level 0 requirements and stipulates conversion of all measurements into kilowatt-hour (kWh). It is more precise than level 0 because it also includes energy sources other than mains electricity. PUE1 is calculated over a 12-month period.

■ Intermediate PUE (level 2)

This measurement includes the level 1 requirements. However the IT consumption is measured at the PDUs (Power Distribution Units). A clear distinction is therefore made between the infrastructure and the IT equipment and it is easier to measure a pPUE (partial PUE).

■ Advanced PUE (level 3)

This measurement includes the level 2 requirements. It refines them by requiring the IT consumption to be measured at device level.

A data center with optimum efficiency will be PUE 1, whereas the average global PUE of a data center is between 1.8 and 1.89 (source: Uptime Institute survey 2012). Reducing this is therefore a priority in order to ensure that the infrastructure provides ever-higher performance.

THREE POSSIBLE ACTIONS TO REDUCE THE PUE :

OPTIMISING THE COOLING SOLUTIONS

→ SEE P. 10

REDUCING POWER LOSSES

→ SEE P. 14

MAKE USE OF PERFORMANCE INDICATORS

→ SEE P. 18

1,8 < AVERAGE GLOBAL PUE < 1,89

NOTE

The Green Grid and ISO/IEC are proposing 4 additional indicators to refine the assessment of the ecological footprint of a data center:

- The Green Energy Coefficient (GEC): this quantifies the proportion of renewable energy consumed by a data center
- The Energy Reuse Factor (ERF): this measures the amount of energy used outside the data center

- The Carbon Usage Effectiveness (CUE): this extrapolates a greenhouse gas emission volume based on the electricity consumption of the data center

- The Water Usage Effectiveness (WUE): this measures the amount of water used in the data center.

For further information, go to www.thegreengrid.org



Optimise the cooling solutions

To obtain the most appropriate solutions, it is necessary first of all to know the class of Data center concerned (see opposite). These solutions will then facilitate the implementation of a global cooling system called "free cooling".

In the context of a free cooling installation, several Legrand cooling solutions for the secondary circuit can be used to optimise the air conditioning. They comply with 2 major thermodynamic principles:

- **Isolation of the hot air from the cold air**
This enables optimum management of air leaks and increases the cooling capacity.
- **Optimisation of the cold air circuit**
Objective: minimize the air friction losses.

The cooling systems are the main item of consumption in a Data center.

To reduce the energy consumption, the consumption by the server cooling systems must above all be reduced.

This involves:

- an optimised design of the white room
- selecting the right cooling solutions

THE LEGRAND ADVANTAGE

Thanks to its worldwide network of partners, Legrand supports you during the decisive stages of your project:

- selection of the right solutions when defining the white room's design
- sizing of the cooling solution in relation to the power of the servers



« FREE COOLING »

Free cooling consists of cooling a building by ventilation using the free energy of the external air or water when it is at a temperature below the required internal conditions. This system also reduces the need to use cooling units, which leads to a reduction in energy bills and improved efficiency of the whole installation (PUE and carbon footprint).

Free cooling includes overall management solutions via the primary cooling circuit and targeted management solutions in the white room via the secondary cooling circuit.

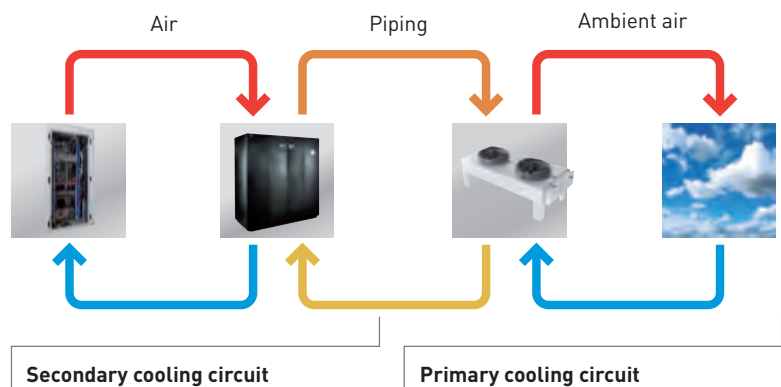

ISOLATION OF THE HOT AIR FROM THE COLD AIR

■ Hot Corridor/Cold Corridor solutions

These consist of separating hot and cold corridors for easier, optimised air distribution.

■ Cold Corridor Solutions

In addition to simply separating the air flows by creating dedicated corridors, the Cold Corridor enables the corridors to be contained for optimised cooling.

The hot air and cold air are separated when the room is designed, using roofs, panels and doors (at the entrance and exit). This very effectively reduces the energy consumption of the air conditioning units (visible reduction via the air conditioning unit consumption reports). The Cold Corridor provides an average of 30% energy savings.

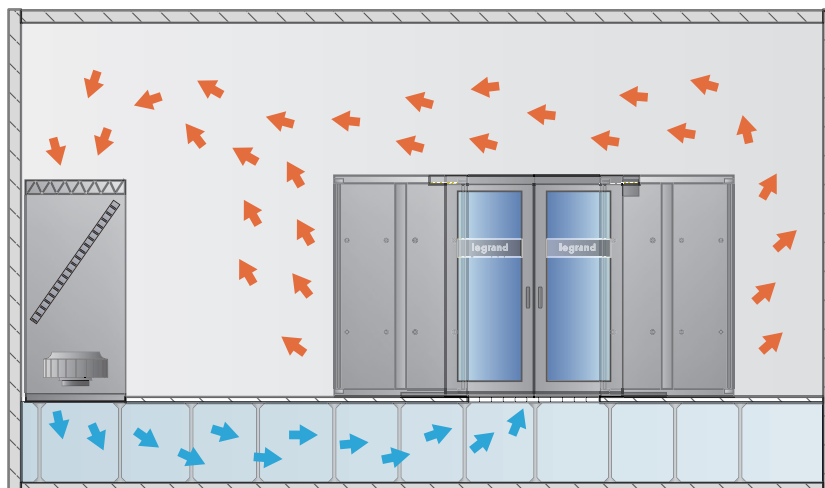

OPTIMISATION OF THE COLD AIR CIRCUIT

■ Cooling the room

This is done using CRAC (Computer Room Air Conditioning) units. Traditionally, the cold air is sent into the false floor at a slightly higher pressure and exits via perforated tiles in the Cold Corridor. The hot air is evacuated in the hot corridor and reprocessed by the unit.

Principle of the room cooling system

COLD CORRIDOR® AN AVERAGE OF 30% ENERGY SAVINGS

STANDARDS

The class (A1 to A4) of a data center, defined by the ASHRAE standard, is assigned according to the equipment in the data center and its specific environmental features.

Equipment (ASHRAE - 2011 Thermal Guidelines)

2011 classes	2008 classes	Applications	IT Equipment	Environmental Control
A1	1	DATA CENTERS	Enterprise servers, storage products	Tightly controlled
A2	2		Volume servers, storage products, personal computers, workstations	Some control
A3	NA			
A4	NA			

Class A1:

typically a data center with tightly controlled environmental parameters (dew point, temperature, and relative humidity) and mission critical operations.

Classes A2/A3/A4:

typically an information technology space or office or lab environment with some control of environmental parameters (dew point, temperature, and relative humidity).

Specific environmental features (ASHRAE - 2011 Thermal Guidelines)

Classes	Product Operations					Product Power Off		
	Dry-Bulb Temperature °C	Humidity Range, non-Condensing	Maximum Dew Pont °C	Maximm Elevation m	Maximum Rate of Change °C/hr	Dry-Bulb Temperature °C	Relative Humidity %	Maximum Dew Pont °C
A1 to A4	18 to 27	5,5°C DP to 60% RH and 15°C DP						
Recommended (Applies to all A classes; individual data centers can choose to expand this range)								
Classes	Allowable							
A1	15 to 32	20% to 80% RH	17	3050	5/20	5 to 45	8 to 80	27
A2	10 to 35		21				8 to 85	
A3	5 to 40	-12°C DP & 8% RH to 85% RH	24				8 to 85	
A4	5 to 45	-12°C DP & 8% RH to 90% RH					8 to 90	

More information, check the ASHRAE 2011 Thermal Guidelines

OPTIMISATION OF THE COLD AIR CIRCUIT (continued)

■ Row-based cooling solutions

These cooling solutions integrated in the corridor (in or between the cabinets) reduce the complexity of the installation and provide cooling as close as possible to the server. Particularly suitable for high density solutions or rooms without false floors, these solutions optimise the air flow so that it is as short as possible, which results in lower losses.

TWO SYSTEMS COEXIST:

■ The H₂O system

Commonly called a chilled water system it uses water for exchanging thermal energy between the secondary system and the primary outdoor system. When the system is running outside a water/glycol mixture is used as a coolant to prevent freezing. The system can be designed as a single loop system avoiding an extra heat exchanger and therefore maximizing the capability of free cooling. The water infrastructure is commonly managed as a circuit for a whole room or is part of a complete building.

■ The Direct Expansion (DX) system

In this direct expansion system, the coolant in the refrigerating machine circulates in the exchangers in contact with the internal air (evaporator) and the external air (air condenser). This is a closed circuit in which each indoor unit is associated with one outdoor unit.

H₂O



Example of
H₂O in
Cold Corridor

DX



Example of DX
in closed loop

H₂O installation diagram

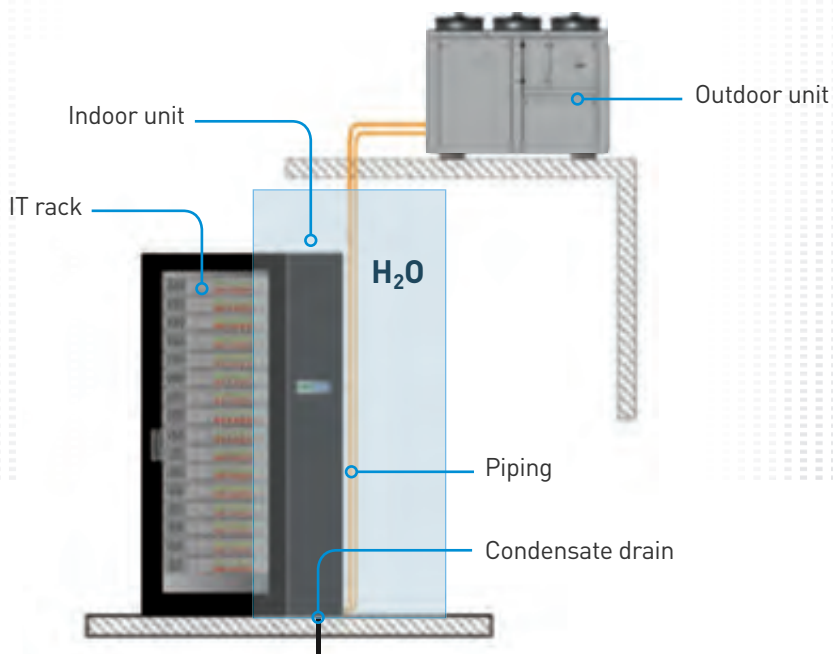

DX installation diagram

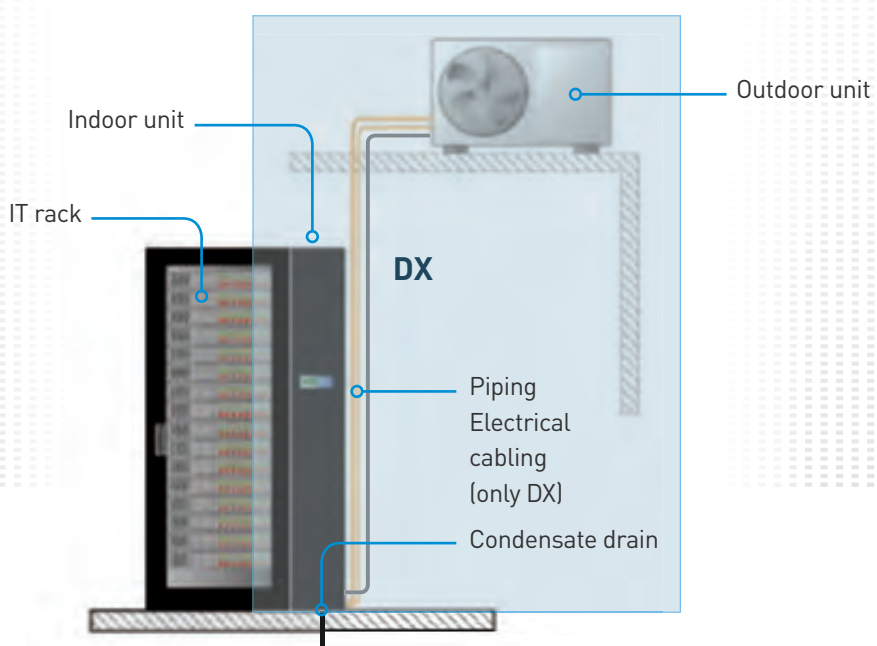

Reduce power losses

The objective is to reduce power losses so as to increase the efficiency of the electrical infrastructure. Power losses connected with energy conversion and UPSs currently represent around 10% of the total energy consumption of a data center, where the cooling alone represents 32%.

Given the efforts made with regard to cooling, particularly through designs enabling the use of free cooling, these power losses will account for a large part of the data center's energy bill.

In order to increase the efficiency of the electrical infrastructure, it is therefore necessary to look into solutions that will reduce this percentage, in particular via the power supply and distribution systems.

Various products, providing high performance installations, improve the quality of the energy and limit power losses, thus reducing the environmental footprint:

■ **Uninterruptible power supplies (UPS)**

These enable the power demand to be as close as possible to the actual requirements

■ **Green T.HE hv/lv transformers**

(Green Transformer High Efficiency)

These high efficiency transformers ensure effective energy efficiency.

■ **Capacitor banks**

These optimise the reactive power and reduce the apparent power of the installation.

PROJECTION OF LOSSES BY IMPROVING THE PUE

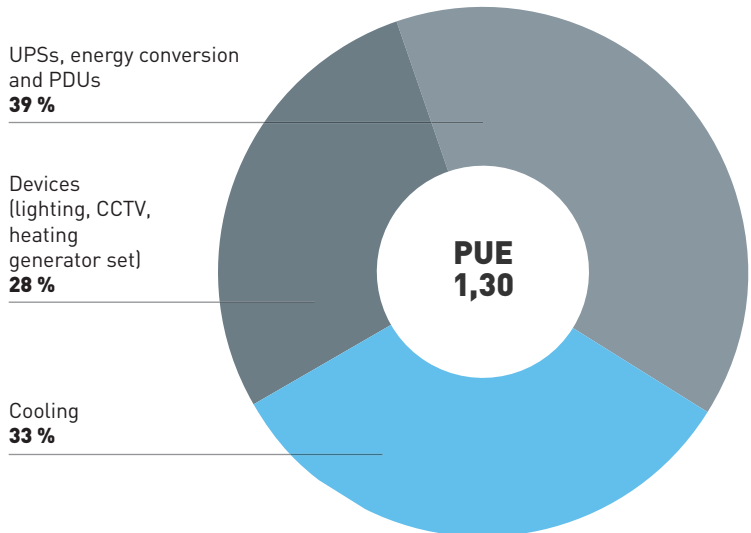
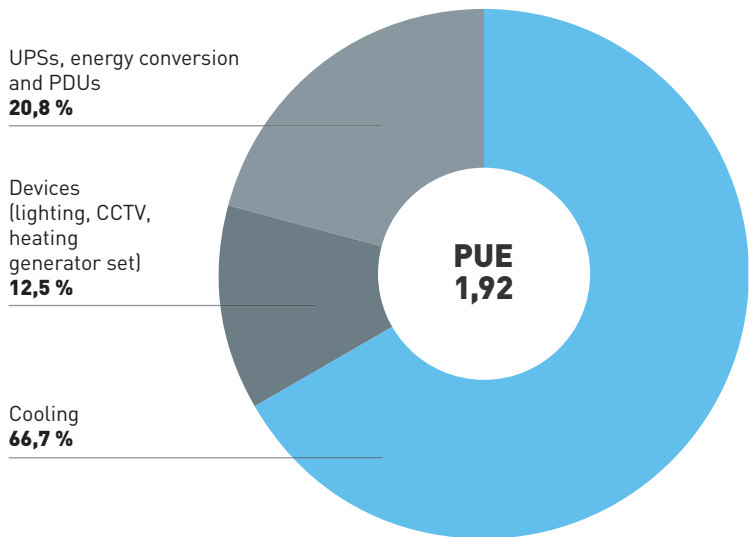



STANDARDS

Various normative documents and certifications guarantee the quality of the supply and distribution systems, thus limiting power losses.

■ Standard EN 62040 & European Code of Conduct on the efficiency and quality of UPS

For uninterruptible power supply (UPS) systems

■ Standard IEC 60076

For power transformers. Refer more specifically to standards EN 60076-1 to 60776-5 and EN 60076-11 version 2004 (for dry-type power transformers)

■ Standard EN 50541-1

This new European standard, published at the start of 2011 and applicable since January 2011, will be compulsory and will replace the national standards in January 2014. It applies to dry-type distribution transformers from 100 to 3150 kVA, up to 36 kV. It defines much lower levels of no-load/on load transformer losses and is easier to read:

No-Load Losses

According to EN 50541-1

P_o

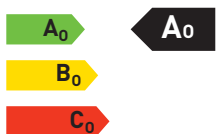

Losses that are still present when the transformer is connected to the net (8760 hours per year) and are independent of the charge

On Load Losses

According to EN 50541-1

P_k

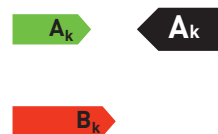

Losses that are quadratic with the charge ($P_k \propto I^2$)

It also establishes noise limits to ensure a level of comfort and limit all disturbance inside the building.

■ Standards IEC 60831-1 and 60831-2

These define the electrical characteristics and robustness tests for capacitors.

■ Standards IEC CEI 61439-1 and IEC CEI 61439-2

For low-voltage switchgear and controlgear assemblies.

NOTE

The reduction of power losses must be worked at on a daily basis, via careful management of the energy requirements. Those responsible for operating a data center must therefore pay attention to the flow and quality of the incoming energy in order to adapt the power demand to the actual requirements of the data center and ensure optimum use of the power received.

As the various power devices operate efficiently at low load conditions (a transformer used at 10% of its capacity is 3 times less efficient than at 60% of its capacity, likewise for inverters and air conditioning units.), their energy management will be optimised and power losses limited.

UNINTERRUPTIBLE POWER SUPPLIES (UPS)

There are 3 types of UPS, depending on the technology of their design:

- single UPS
- distributed (or centralised) parallel UPS
- modular UPS

UPS, with optimised energy efficiency, ensure the power demand is as close as possible to the actual requirements and reduce power losses. In fact, if the efficiency of the UPS is increased, it will give off less heat, which will reduce cooling and consumption losses. Legrand offers UPS solutions that can achieve efficiency levels of up to 96% mode Online (VFI - Voltage Frequency Independent double conversion).



EFFICIENCY LEVELS UP TO 96%* WITH LEGRAND'S UPS!

NOTE

The power of a UPS is usually described in kVA, but a data center is sized in kW because it is necessary to know the actual active power to be supplied.

The power factor of the UPS, i.e. the ratio between the active power (in W) and the apparent power (in VA), is therefore a very important indicator of its performance. It often reaches 0.8, while high performance UPS have a power factor of 0.9 or even 1 (which is the case with Legrand UPS). This means that when 80 kW is required, an 80 kVA UPS with a power factor of 1 will be adequate, whereas a UPS with a power factor of 0.8 at the output must be sized at 100 kVA.

The electrical infrastructure (rating of the circuit breakers) will therefore be better sized.

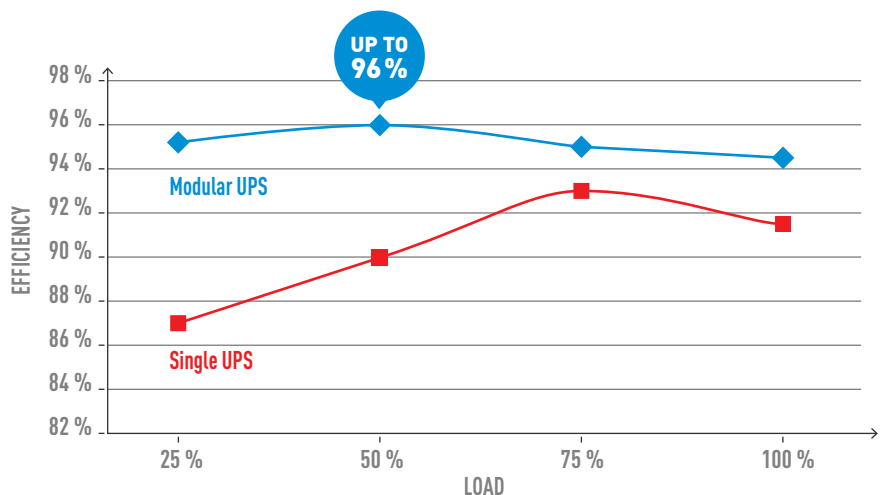

* Mode Online (VFI - Voltage Frequency Independent double conversion).

GREEN T.HE HV/LV TRANSFORMERS

These provide high energy efficiency and a lower environmental footprint (fewer pollutants).

An average of 3 times fewer losses is observed with these high efficiency transformers than with a standard transformer.

The Legrand Green T.HE offer gives you access to classes R(BoBk), BoAk, AoBk and AoAk solutions. The new classification according to standard EN 50541-1 stipulates that the transformer with the lowest losses will be class AoAk.



Legrand
Green T.HE
transformers



Monitorable
capacitor bank

CAPACITOR BANKS

These optimise the reactive power and reduce the apparent power (kVA) of the installation, enabling the reactive energy penalties applied by the power suppliers to be avoided. They also:

- make less demands on the transformer
- limit active losses in the cables given the current carried in the installation
- improve the voltage level at the end of the line

Equipped with passive filters or anti-harmonic reactors to protect the capacitors against the high levels of harmonics, they may be integrated in the design of the LV distribution board.

THE LEGRAND ADVANTAGE

To size your capacitor bank correctly, the Legrand group offers a service to assess your actual need when your building is in service and in nominal operation. The assessment will give you the real saving resulting from sizing your capacitor bank correctly.

Make use of performance indicators

For greater efficiency, solutions for optimising the cooling systems and those to reduce power losses can be combined with measurement and supervision systems. These systems provide real-time information on consumption per application, the overall consumption of the installations and the power consumed by the equipment. Energy expenditure can then be reduced by implementing corrective actions.

There are three possible measurement points:

- overall consumption of the data center
- consumption downstream of the UPS
- overall consumption of a rack and/or a server

RECOMMENDED PUE LEVELS ACCORDING TO THE TYPE OF DATA CENTER:

PUE >	Level 1	Level 2	Level 3
ENTERPRISE	OK		
CORPORATE		OK	OK
COLOCATION		OK <small>IF RENTING A RACK</small>	OK <small>IF RENTING A SERVER</small>

OVERALL CONSUMPTION OF THE DATA CENTER, FOR ALL PUE LEVELS

This involves measuring the total energy consumed by the data center (in the equipment room). Measurement of consumption must be included in the main LV distribution board, thus enabling the losses of the UPS, the power consumed by cooling and the consumption of the IT equipment to be consolidated.



MB
For example at each outgoing line, display and measurement of harmonics, consumption history

CONSUMPTION DOWNSTREAM OF THE UPS, FOR LEVEL 0 OR 1 PUE

■ In the secondary distribution boards

The energy consumed per phase is measured. For computer rooms which are heterogeneous in terms of equipment, it should be noted that the consumption varies from one phase to another. To enable maintenance to re-balance the phases, it is useful to include measurement modules in the secondary distribution boards in the rooms, with direct display of the currents per phase.

■ Via the UPS

It is possible to feed back consumption data using electronic cards inside the UPS.



SB
For example low consumption/high environmental quality building. Detailed measurements for each application

OVERALL CONSUMPTION OF A RACK (FOR LEVEL 2 PUE) AND/OR A SERVER (FOR LEVEL 3 PUE)

This involves measuring the energy consumed by the IT systems.

This is done using Power Distribution Units (PDU) which can measure the current, the voltage and the power factor for all sockets or per socket.

They thus avoid any measurement errors (which could be as much as 10% when calculating the energy) which could result in a fixed value for the voltage and the power factor.

NOTE

For a level 2 PUE, it is possible to:

- locate the measurement remotely from a PDU for the consumption of a rack at its upstream protection device, thus enabling a basic PDU to be used.
- integrate measurement in the tap-off boxes connected to the prefabricated busbar trunking .





1 Row-based cooling - H₂O system
→ SEE P. 12

ENTERPRISE

PRODUCTS SOLUTIONS



1 Row-based cooling - DX system
→ SEE P. 12



2 Archimod UPS
→ SEE P. 16

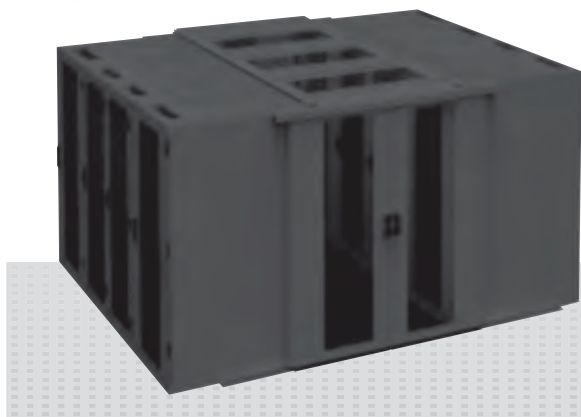
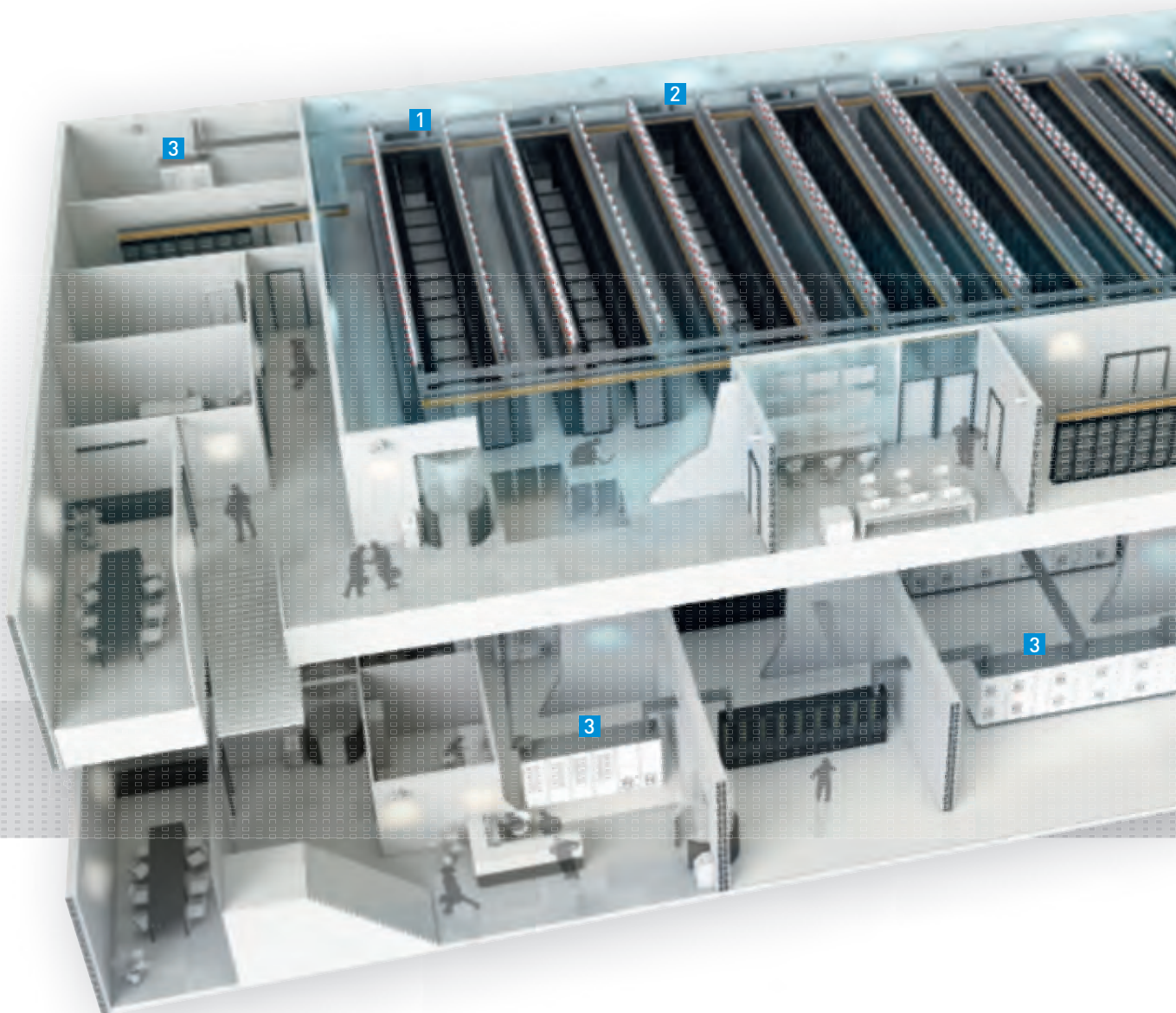

1 Cold Corridor®
→ SEE P. 11



2 Colocation cabinets

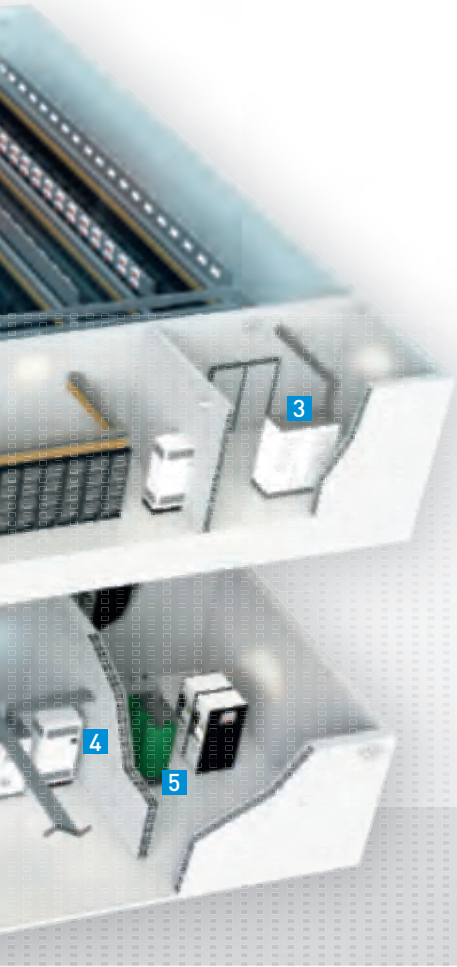

CORPORATE & COLOCATION

PRODUCTS SOLUTIONS



3 XL³ 4000 cabinets and e•communication measurement
→ SEE P. 19



4 Capacitor banks
→ SEE P. 17



5 HT/BT Green T.HE transformers
→ SEE P. 17

Awañaiti
Awañaiti

2 AVAILABILITY

OBJECTIVES:

- Constant access to a high-performance network 28
- Carry out work with no break in service 34

Context & issues

A 1 hour outage of a trading room can represent a loss of up to 6 M€.

In most buildings, the economic and/or safety and security issues necessitate reliable availability of energy and data, and the costs associated with a loss of operation can be very substantial.

Ensuring reliable availability of energy and data involves first and foremost maintaining the electrical and digital supply of the data center throughout the year. To do this, the owner of the data center must first determine the availability required for all the equipment and infrastructures by means of an assessment of the risks and costs associated with any downtime.

CLASSIFICATION INTO TIERS

The data center is assigned a Tier according to the required availability. This ensures a certain level of continuity of power supply and service. The Tier classification classifies data centers according to the degree of reliability and availability of data in accordance with standard ANSI/TIA-942 and the Uptime Institute certification.

■ Tier 1

1 single path for the power supply and the cooling, with no redundancy of the components.

Nominal availability corresponding to a cumulative annual downtime of 28.8 hours.

■ Tier 2

1 single path for the power supply and the cooling, but with redundant components. 99.749% nominal availability (i.e. 22 hours annual downtime).

■ Tier 3

(concurrently maintainable data center)

Several power supply and cooling paths, one of which is active. Some components are duplicated and maintenance can often be carried out without having to shut down the machines.

99.982% availability (i.e. 1.6 hours annual downtime).

■ Tier 4

(fault tolerant data center)

Several active paths in parallel for the power supplies and the cooling. Numerous infrastructure components are duplicated and fault tolerant.

99.995% resulting availability (i.e. 0.4 hours annual downtime).

APPLICATION EXAMPLES¹

AVAILABILITY	TIER 1	TIER 2	TIER 3	TIER 4 ²
Availability for all equipment and infrastructures	Low/Poor	Medium	High	Very high
Example for power distribution (see standard EN 50600-2-2)	Single-path (no redundancy of components)	Single-path (resilience provided by redundancy of components)	Multi-path (resilience provided by redundancy of systems)	Multi-path (fault tolerant even during maintenance)
Example for environmental control (see standard prEN 50-600-2-3)	No specific requirements	Single-path (no redundancy of components)	Single-path (resilience provided by redundancy of components)	Multi-path (resilience provided by redundancy of systems), allows maintenance during operation
Example for telecommunications wiring (see standard prEN 50-600-2-4)	Single-path using direct connections	Single-path using fixed infrastructure	Multi-path using fixed infrastructure	Multi-path using fixed infrastructure with diverse pathways

¹ The requirements and recommendations giving the required protection classes (to ensure availability of equipment and infrastructures) are appear in:

- Standard EN 50600-2-1, for the construction of a data center.

- Standard prEN 50600-2-5, for the physical protection of the data center.

² The class 4 multi-path solution (fault tolerant even during maintenance) is mentioned standard prEN 50600-2-3

Legrand's response

AVAILABILITY CONSIDERED CAREFULLY AT EVERY STAGE

■ When designing the data center

Legrand can work with you on the entire design of the data center's infrastructure. Objective: to help you identify critical items which could reduce the level of service (and thus lead to a loss of continuity) and to suggest solutions to avoid too high a level of redundancy in order to optimise costs, while maintaining service. Example of a solution: synchronisation of two main LV distribution boards.

■ When developing the systems

It is essential to design distribution, power supply and equipment supervision systems etc. using innovative systems which enable constant access to a high performance electrical/digital network and any work (changes, maintenance, etc.) to be carried out on the installation with no break in service.

THE « RIGHT » TIER FOR THE DATA CENTER

For optimum availability of energy and data, it is important to take the surface area of the data center into consideration in order to determine the most appropriate Tier.

DESIGN INNOVATIVE SYSTEMS WHICH ENABLE:

CONSTANT ACCESS TO A HIGH PERFORMANCE ELECTRICAL/DIGITAL NETWORK

→ SEE P. 28

ANY WORK TO BE CARRIED OUT ON THE INSTALLATION WITH NO BREAK IN SERVICE

→ SEE P. 34

MINIMUM RECOMMENDED TIER ACCORDING TO THE SIZE OF THE DATA

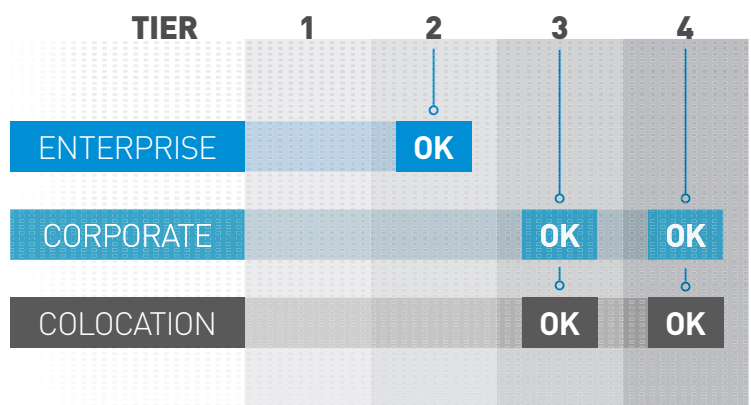

source: Legrand

THE LEGRAND ADVANTAGE

Legrand has a centralised expert department which can provide you with expertise in its various competitive areas, working with you to define technical solutions by looking at the project as a whole, over and above single products.

Constant access to a high performance network

The availability of data, and therefore the servers, is assured if the cooling, its power supply and its connectivity are always assured if a component in the infrastructure fails or if maintenance has to be carried out.

Constant accessibility to a high performance network is based on 3 main factors.

■ Continuity of service

This involves above all providing a clean power supply with no electrical disturbance (micro-breaks, overvoltages, undervoltages, etc.) and choosing solutions that enable components to be changed with no break in service.

■ Performance and reliability of solutions

This involves selecting products which are reliable, due to both their design and their integration, whose connectivity performance levels ensure an optimum rate.

■ Access to network

This involves implementing comprehensive productivity solutions enabling a reduction of time taken to perform work via network identification solutions and via systems designed so as to give better access in case of interventions.

CONTINUITY OF SERVICE

■ Uninterruptible Power Supplies (UPS)

Legrand has a range of UPS (modular, synchronisable, etc.) with a various performance levels (from 10 to 4800 kVA), thus able to meet all requirements. The guarantee of optimum continuity of service!

■ Electrical distribution cabinets

Discover our increased safety solutions on page 35!

PERFORMANCE AND RELIABILITY OF SOLUTIONS

Ensuring a data center is constantly available involves selecting solutions that ensure correct operation over time. For this, the Legrand group develops and designs its high performance products and systems with safety margins well beyond those in the standards, to ensure they operate correctly irrespective of the environment in which the systems are installed and used.

■ Dry type transformer

This is one of the most reliable products in the electrical infrastructure:

- once it has been commissioned, it requires very little maintenance in comparison with an oil-immersed transformer, which has to be inspected regularly
- it does not contain any moving parts, or any insulating fluids: there is therefore no risk of leaks or any need for regular maintenance

It also has a one year warranty which can be extended to 5 years including regular monitoring of your installation.



STANDARDS

The reference standards for availability mainly concern structured cabling. They include the project and the installation of the system as a whole, and also the technical characteristics of each component. Although the standards are structured differently for each continent, they all cover all the important topics and contain in particular the requirements for performance, safety and conformity of installations.

INTERNATIONAL

- ISO/IEC 11801 standards

EUROPE

- EN 50173 standards
- EN 50174 standards
- EN 50-600 standards

UNITED STATES

- EIA/TIA 568-C standards
- EIA/TIA 942 standards

For further information, see p. 65

■ Capacitor bank

The design of these is completely dry. They incorporate capacitors:

- Designed to last and to withstand the stresses of the electricity supplies: overvoltages, harmonic pollution, etc.
 - With a tolerance significantly higher than in the standards ($U_{max} = 1.18 U_n$ constantly)
- The service life of the compensation system is therefore increased.

■ Structured cabling systems

The LCS² structured cabling system ensures high performance and reliability for the installation via zero fault solutions and routing systems that are ideal for copper and optical fibre cables.

ZERO FAULT SYSTEM

LCS² fibre optic solutions can be used to create wiring architectures for the LAN and SAN infrastructures of data centers with OM3, OM4 performance levels in multimode and OS1/OS2 in single-mode.

SELECT THE IDEAL FIBRE OPTIC SOLUTION!

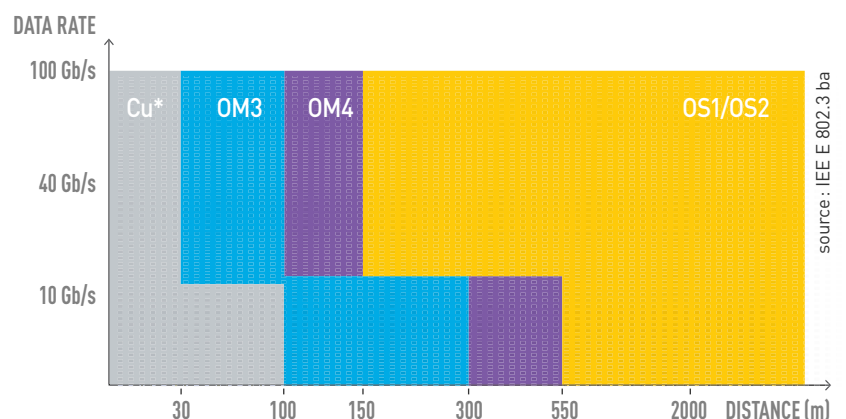

*Draft versions ISO/IEC and EIA/TIA. standards in process

source: IEE E 802.3 ba

PERFORMANCE AND RELIABILITY OF SOLUTIONS (continued)

To ensure the 40/100 Gbps and Fibre Channel protocols are supported, opt for LCS² fibre optic solutions with high density MPO/MTP[®] connectors!

As for the LCS² copper solutions, they provide performance levels exceeding those of the reference standards up to class E_A, with category 6_A components certified by independent laboratories.

All the LCS² components are tested individually at the end of production and their excellent performance levels over short links (less than 15 m) ensure availability of the bandwidth at the highest frequencies. As for the Legrand RJ 45 and fibre optic connectors, their design ensures they comply with the installation regulations: correct installation is thus assured!

CAT. 6_A PERFORMANCE

With LCS² category 6_A, Legrand guarantees installed channel performance exceeding all category 6_A crosstalk requirements by 5 dB / TIA* or 3 dB / ISO* and exceeding all category 6_A return loss requirements by 3 dB / ISO-TIA* for configurations and installations conforming to standards, as well as on-site testing conducted by verified testing agents.

* Depending on the degree of accuracy offered by the tester at the test point.

CAT. 6_A EXCEEDS ISO-TIA STANDARD REQUIREMENTS BY UP TO 5 dB

NOTE

■ Optical fibre

This is a transmission medium that enables a larger bandwidth to be used than copper cables. Optical fibre cables have major advantages over copper cables: total immunity to electromagnetic interference, high transmission capacity, low attenuation, much smaller cable sizes (10 times smaller than a copper cable)...

■ Category 6_A / Class E_A

There are 2 descriptions in the standards: a US version with category 6_A (from the EIA/TIA series) and an ISO/IEC version with class E_A (using cat. 6_A components).

The performance levels of cat. 6_A and class E_A structured cabling support 10 Gigabit Ethernet on a copper link up to 100 metres. Yet, cat. 6_A and class E_A do not reach the same performance levels: ISO/IEC class E_A provides the highest performance level available on RJ 45 technology. In practice, this better performance level results in higher

operational reliability, reducing transmission errors to a minimum. The service life of the cabling infrastructure is also maximised. Class E_A solutions thus provide assured continuity of the link, high performance equipment and a durable IT network. Beware, however: on a short link RJ 45, the echoes of the emitted signal are amplified as they are less attenuated by the cable length, which - on a normative aspect - imposes a minimum distance of 15 m on the Class E_A link!

■ High Density (HD)

The main advantage of HD fibre optic solutions (panels, racks, fibre optic drawers, cassettes, etc.) is a large number of physical connections in a minimum amount of space.

Another advantage is that they can be used for a scalable 40 or 100 Gigabit installation.

ROUTING SOLUTIONS

Given the number of digital links in a data center, it is important to ensure the durability of the existing installations and avoid collateral damage which could lead to wiring changes. For this reason the Legrand group, world leader in cable routing, has developed dedicated data center solutions which ensure:

- compliance with the permitted bending radiuses for copper and fibre optic data transmission cables, with:
 - the Cablofil OFT P31 range
 - a wide range of accessories for server racks and HD racks
 - firestop partition feedthroughs with the EZ Path system



Cablofil cable tray: patented T-joint system

- protection of the cables when they are installed or replaced, with:
 - Cablofil cable trays and their patented T-joint system
 - the automatic cable fixing system on LCS patch panels without cable ties
- compliance of the hot and cold air flows with the ranges of short (< 1 m) LCS² cords and the vertical fixing system for the panels at the rear of the server cabinets.

COMPLETE LEGRAND CABLE MANAGEMENT SOLUTION

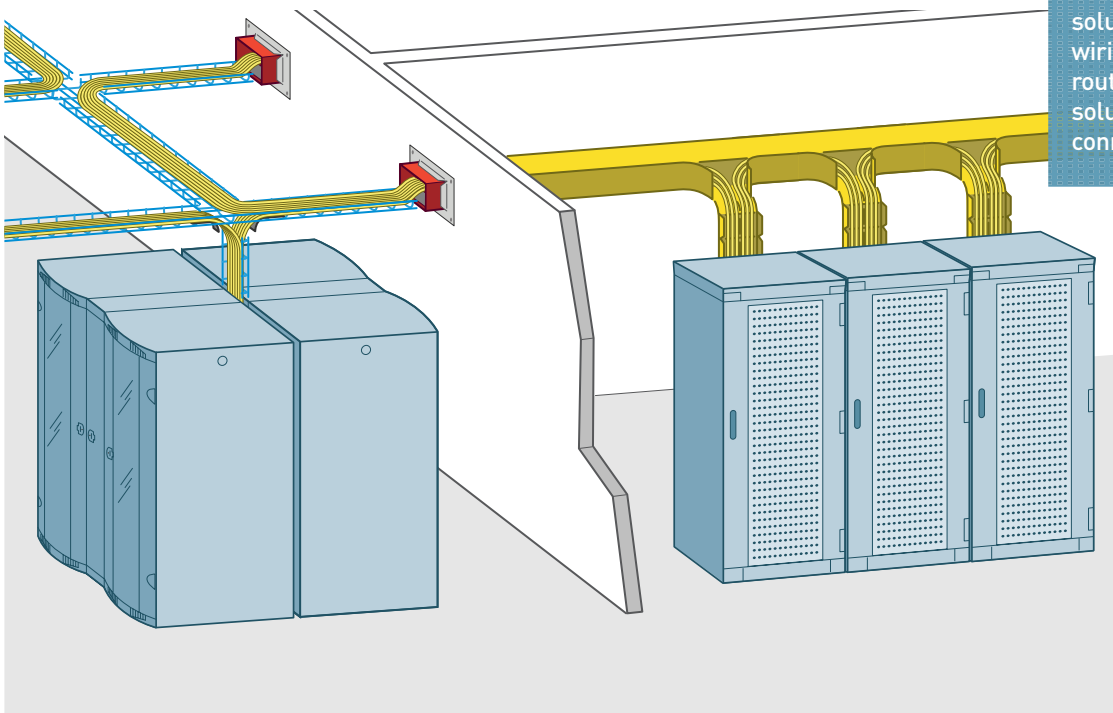

NOTE

The complete Legrand solution (racks for the wiring, server racks and routing) enables LCS² solutions pre-fitted with connectors to be added!

ACCESSIBILITY TO THE NETWORK

■ Network identification systems

In its LCS² solutions, the Legrand group gives more space than average to the alphanumeric means of identifying the connections on copper and fibre optic patch panels, in both standard and high density solutions. Thus, all 19" uprights for fixing in wiring racks and server racks incorporate marking of the units that can be read from the top or the bottom.

It is also important to identify the various flows (copper, fibre optic, technical network, etc.). Legrand can therefore offer you solutions with panels/cords (LCS²) and cable trays (OFT P31 and Cablofil) in various different colours for optimum identification!

■ Accessibility

LCS² panels are accessed and connectors attached via the front, and they have a quick fixing system on 19" uprights.

The LCS² very high density fibre optic drawers, which can take up to 120 LC connectors in 1 U and 288 in 2 U, maintain access for connecting and disconnecting cords without the need for any special tools due to their unique fibre optic feedthroughs.



Marking of the units on 19" uprights



Various colours for cords and patch panels' labels



Simple unclipping of LCS² connectors



OFT P31 cable trays are available in 6 different colours

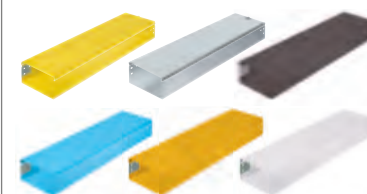

NOTE

As servers consume increasing amounts of energy, thermal undersizing must be avoided as it could lead to faults (due to overheating of the infrastructure) and a break in continuity of service. A data center therefore requires solutions that provide continuous cooling of the equipment, for a building that provides even better performance!

It is therefore important to choose products that provide high thermal density, such as air conditioning units, the Cold Corridor[®], etc.

This high thermal density ensures:

- internal modularity of the fans that can be hot-swapped for ease of maintenance, and an optimum power supply
- absolutely no contact between the connections of the water inlets (lower part of the units) and the electrical inlets (upper part)
- simple, effective visual feedback for quick identification of alarms

For further information, see p. 10 to 13 (Efficiency)



Easy maintenance
for even more
efficient buildings

Carry out work with no break in service

Critical applications such as data centers require a high degree of availability at all times and under all circumstances.

It is therefore essential to ensure this high availability and optimise it in order to mitigate any possibility of faults or need for maintenance without having to interrupt service.

There are three systems for this:

■ « Hot plug »

« Hot plug » products can be connected/disconnected while energised, thus providing a great deal of flexibility for carrying out work.

■ « Hot swap »

« Hot swap » components can be replaced while energised, thus ensuring optimum continuity of service under all circumstances.

■ Modulare architecture

This provides a scalable installation with no loss of performance.

NOTE

The Hot Plug system is also used for managing maintenance and managing the scalability of the installation, enabling the time taken for work to be reduced considerably and therefore increasing the availability of data centers.



« HOT PLUG » SYSTEM

This system enables components to be connected and disconnected in an installation while energised, without any interruption to the system and with no risk of damaging the rest of the installation. Even when high currents are interrupted, continuity of service is assured.

The Hot Plug system can be applied to various components in an installation, such as the low voltage electrical panel, energy distribution solutions in the computer room, IT equipment, etc.



« Hot plug » energy distribution solutions: optimised availability guaranteed!

You want to be able to perform maintenance with no break in service?

■ Low voltage electrical panel

In the context of the IEC 61439 standards, which govern low voltage electrical panels, the concepts of connection/disconnection associated with requirements for upgrading the panel are essential. To meet these requirements, the Legrand group uses two indexes which provide information on the level of continuity of service of an electrical panel, which are assigned to the panel according to its characteristics and its components: the Service Index and the Mobility Index.

SERVICE INDEX (IS)

French reference index, its aim is to define the service level provided by any type of low voltage distribution panel when undergoing all types of work, during the three phases of its life (operation, maintenance, upgrading). It takes the form of a 3-number code. The IS, through the choice it offers, helps to augment the continuity of service and the safety and security of the installation.

Although this index is not mentioned in the IEC 61439 series of standards, there is certainly some correlation, in particular with regard to the « Mobility index ».

MOBILITY INDEX

International reference index determining the design of the functional units in the panel, it takes the form of a 3 letter code. (see page 36).



→ **YES**

FORM OF THE FUNCTIONAL UNIT	3	4
Minimum IS required for the LV panel	DDD	WWW
MOBILITY INDEX	231	331
IS INDEX		

→ **YES**

FORM OF THE FUNCTIONAL UNIT	3	4
Minimum IS required for the LV panel	WWW	FFF
MOBILITY INDEX	321	221, 222, 223
IS INDEX		322, 323

→ **NO** **Implies complete power shutdown during maintenance operations**

FORM OF THE FUNCTIONAL UNIT	1	1*
Minimum IS required for the LV panel	FFF	WWW
MOBILITY INDEX	111, 211	311
IS INDEX		

*No protection of live parts

« HOT PLUG » SYSTEM
(continued)

STANDARDS

The main preliminary step for sizing the energy source(s) is to carry out a « power analysis », to ensure there is an optimum power supply for all the consuming receivers in the data center: lighting, heating, air conditioning and utilities, etc. and of course the racks and IT systems. This power analysis must take the conditions of use, possible degraded modes (no power) and even electromagnetic interference (harmonics) into account in the dual interests of continuity of service and energy saving. The quality of the energy (standard EN 50160) and the distribution conditions (supplier, operators, proportion from renewable sources, etc.) are parameters which must also be managed in this operation.

Standard EN 50600-1 gives general design recommendations for data center installations and infrastructures.

Standards EIA/TIA 942-A (US version) and EN 50600-2-2 (EU version) give recommendations on energy distribution, in particular for the Service index/Mobility index.

The Green Grid, an international reference system, also provides advice on configuring energy distribution systems.

In addition to the specific standards, it is essential to comply with the safety standards specific to electrical installations and data processing equipment.

For further information, see p. 58-60 (Safety and Security)

IS and Mobility index: the codes

Service
Indice

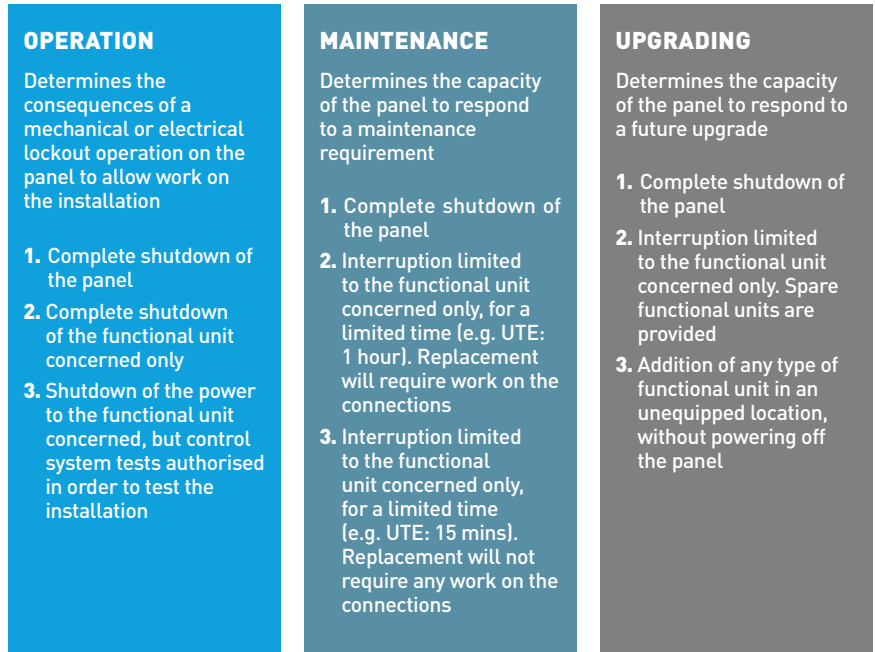

Mobility index

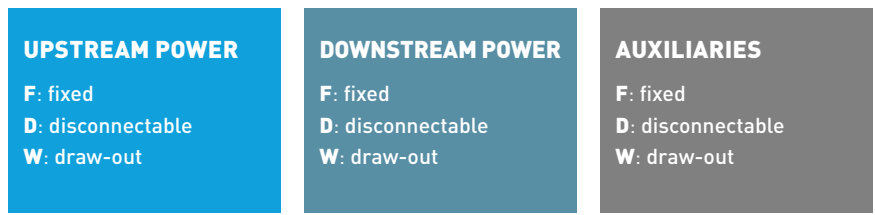



MR busbar solution with tap-off box

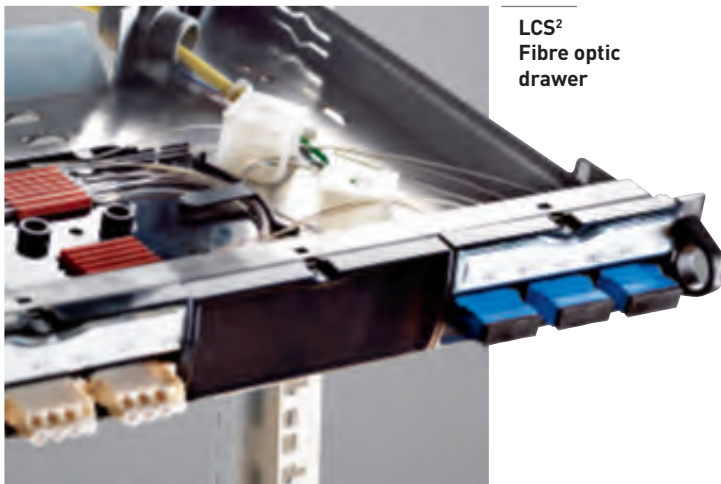

LCS² Fibre optic drawer

■ **Energy distribution solutions in the computer room**

The MR busbar range solution, with tap-off outlets, can be used to connect and disconnect tap-off boxes supplying a PDU while energised.

(see solution p. 50 - Scalability section)

■ **IT equipment**

Essential for relaying data, the patch panels, racks and other fibre optic drawers must allow constant data transmission. To do this, hot connection/disconnection is essential. This means making the installation scalable with no risk of damage to existing equipment and connections.

NOTE

For a cost-effective solution, the Legrand solutions enable the service indexes in a set of cabinets to be mixed. Example: a cabinet already equipped as IS 231 or 331 and an IS 223, 233 or 333 reserve cabinet.

To find out more, consult our Product Guide « Distribution system » available on www.datacenter.legrand.com





« HOT SWAP » SYSTEM

This system enables components to be added or replaced in an installation while energised, without any interruption to the system and with no risk of damaging the rest of the installation.

Uninterruptible Power Supplies, which switch the supply to a backup battery for a short while if there is an electrical problem (thus protecting the equipment and the data), can consist of hot-swappable components such as the batteries.

As the ability to change a UPS module is essential for the scalability of an installation, Legrand « On-line double conversion » modular UPS all incorporate a hot swap system. This ensures optimum continuity and quality of the electricity supply.

NOTE

« On-line double conversion » technology consists of converting the current supplied via the raw mains supply twice before supplying the installation: once to DC via the rectifier, and once to AC via the inverter. This provides increased protection against power cuts and micro-cuts, interference, frequency variations, voltage dips, overvoltages, lightning, etc.



MODULAR ARCHITECTURE

Making an installation scalable without any loss of capacity involves above all choosing solutions that provide a modular architecture which guarantees optimum performance in all circumstances.

■ **At UPS level, with modular solutions**

The integrated n+1 architecture of Legrand modular UPS makes it possible to work on a module while maintaining the capacity « n » necessary for the installation, or even « n+1 » if a module is available in stock. Upgrading or repair work can therefore be carried out while maintaining optimum operation of the UPS. Moreover, the return to an n+1 situation is much quicker with modular UPS, as the mean time to repair is less than 10 min.

■ **At system level, with parallelable solutions**

The n+1 architecture of the Legrand parallelable UPS enables work to be carried out on a module while maintaining capacity « n ».

MODULAR UPS MEAN TIME TO REPAIR < than 10 min

NOTE

All Legrand UPS are optimised so that they provide maximum energy efficiency between 25 and 100% load, which ensures optimum efficiency in the various types of architecture (n+1 or 2n).

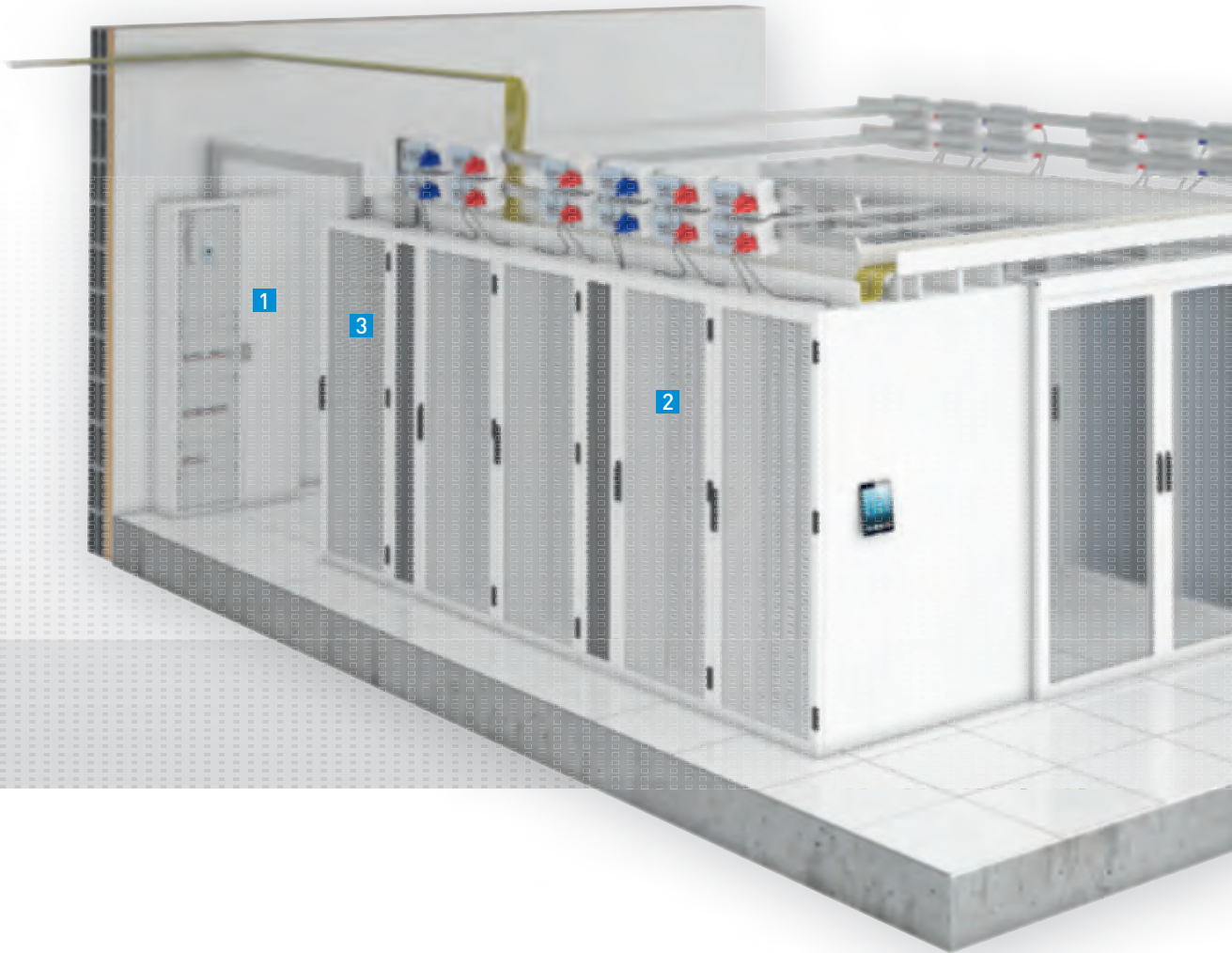

ENTERPRISE

PRODUCTS

SOLUTIONS

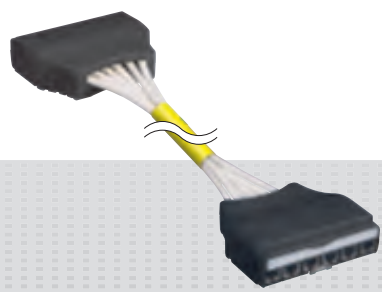
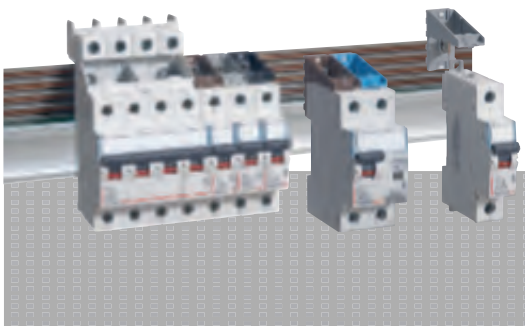

1 IS223 distribution system
→ SEE P. 35

2 LCS² solutions
→ SEE P. 32

3 Modular UPS
→ SEE P. 39

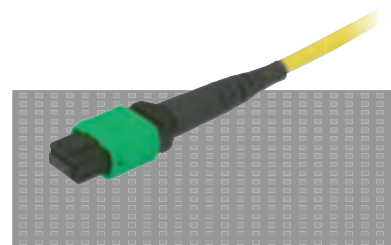
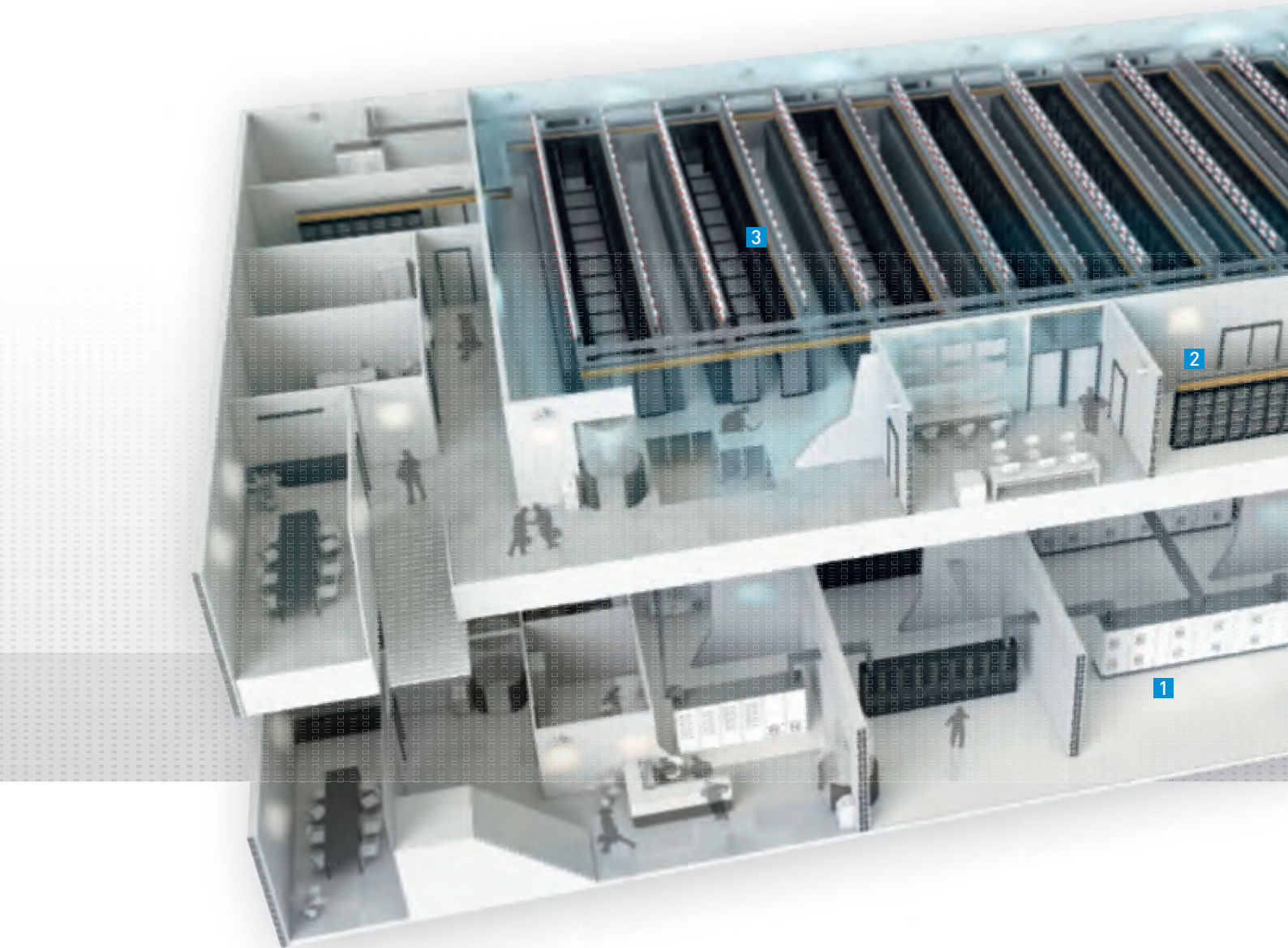

MPO/MTP® Connector

MTP® is a registered trademark of the US Conec Ltd

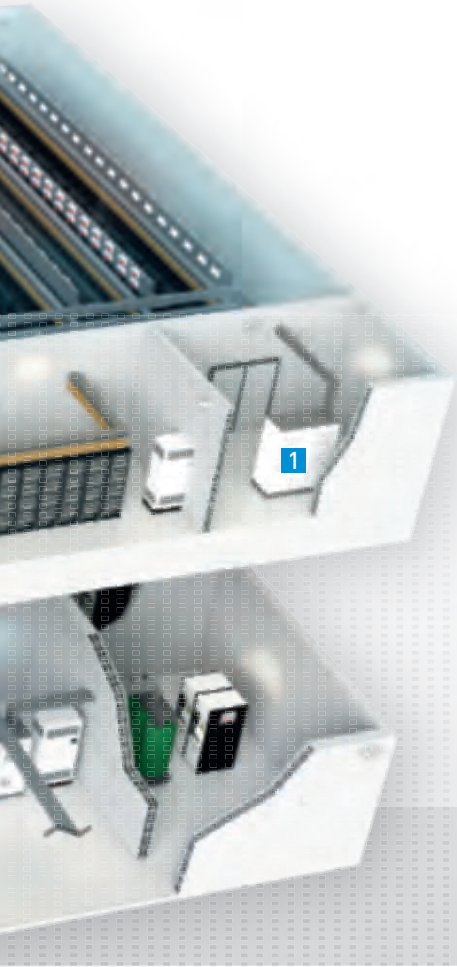

CORPORATE & COLOCATION

PRODUCTS SOLUTIONS

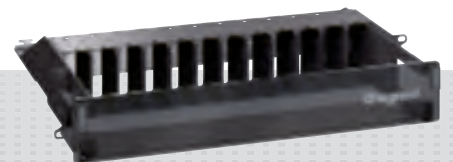

1 IS233/IS333 distribution system
→ SEE P. 35

2 HD LCS² solutions
→ SEE P. 32

3 Optic drawer
→ SEE P. 37

Secularism

3 SCALABILITY

OBJECTIVES:

- Anticipate needs 48
- Increase capacity 50

Context & issues

A huge 4400 % increase in data is expected by 2020.

In the era of virtualisation and cloud computing, a massive increase in the volume of data is expected: the annual growth in data is expected to rise from 50% in 2010 to reach 4400% in 2020 (source: Gartner Research). This rapid growth will have a major impact on how we design our server rooms, with scalability becoming vital. In fact it will be essential for a server room to adapt to constantly changing requirements dictated by the growth in volumes of data. Conversely, virtualisation and cloud computing will have less and less impact on the physical sizing of server rooms. But this temporary phenomenon will be followed by a significant increase which will then necessitate the physical expansion of server rooms. The massive growth in data volumes forecast over the coming years will contribute to this considerably.

REQUIRED FLEXIBILITY OF THE SERVER ROOM

The temporary physical reduction in the size of server rooms will lead to increased energy density due to the use of servers with medium and high density power requirements. Due to the changing needs in terms of numbers of racks and power and the fluctuations that this involves in terms of cooling, it is essential for the design of server rooms to be flexible and scalable.

A MODULAR APPROACH

It must therefore be possible for the capacity of a modern server room to be increased or decreased quickly and easily. It is therefore clear: the building of server rooms requires a modular approach in order to provide an optimum response to current and future needs and to changes in the market.

A modular approach to building a server room involves a great deal more than simply making it easy to add or remove racks: modularity also applies to the energy distribution, the backup power supply, the cooling, the network, etc. This enables the need to constantly adapt the consumption of the server room to the needs of the computer installation.

THE LEGRAND ADVANTAGE

All Minkels data center solutions are designed based on the concepts of scalability and flexibility.

Legrand's response

Minkels has therefore developed dedicated solutions for you, providing an infrastructure that is scalable at all levels: from energy distribution to data housing, and including cooling solutions.

These solutions enable you to anticipate needs, so as to make future upgrades possible, and to increase the capacity of the data center so that you can respond to your increasing requirements, in order to optimise the CAPEX/OPEX

SOLUTIONS ENABLING TO:

**ANTICIPATE
NEEDS FOR
FUTURE UPGRADES**

→ SEE P. 48

**INCREASE THE
DATA CENTER
CAPACITY**

→ SEE P. 50



Modular data center

Anticipate needs

The infrastructure requirements of all data centers have to change, all the more so with the increasing emergence of cloud computing. Anticipating future needs is therefore essential: adapting the physical space in the data center for the envisaged workload and the possible changes is therefore a real necessity.

Legrand recommends that you take the scalability of the infrastructures into account at every stage.

■ **When designing the data center**

Our teams are available to support you in considering this as a whole!

■ **When selecting solutions to be implemented**

This means choosing products that provide access to greater performance with minimum dimensions and which enable you to keep some space in reserve, providing an optimised and scalable area.

DESIGN

Legrand can work with you on the entire design of your infrastructure: the group has a centralised expert department which can provide you with expertise in its various competitive areas, working with you to define technical solutions by looking at the project as a whole, over and above single products.

Our expertise is your assurance of having a data center with optimum design, guaranteeing you reliable communication between the various interfaces.

CHOICE OF SOLUTIONS

There are two objectives: to optimise the space for optimum performance in minimum space, and to keep some space in reserve so that new devices can be added while the installation is energised.

■ **Optimising the space**

The LCS² HD range, with MPO/MTP[®] connectors, provides an infrastructure which supports today's most commonly used protocols on Ethernet and Fibre Channel. It is also tested to ensure it can be upgraded to the 40 Gbps and 10 Gbps protocols. This range therefore gives you access to higher performance levels without requiring any additional space. For example, it provides access to more connection points than a standard range, within a minimum amount of space.

Legrand compact products, such as the 4-module 4-pole RCBO, are small-sized protection solutions: guaranteed space-saving with no loss of efficiency!

NOTE

The Legrand group designs its products and solutions in such a way that it is possible to upgrade its systems.

You want a scalable installation?

■ Keeping some space in reserve

PHYSICAL SPACE

It is important to keep some space in reserve in the secondary distribution board to maintain the scalability of the data center. A cabinet that is large enough to provide sufficient reserve space must therefore be chosen from the outset. With pre-equipped space in reserve, there is no need to switch off the main supply when making modifications to the installation: scalability and continuity of service are assured.

ENERGY DISTRIBUTION

The use of modular UPS with a chassis with a high enough rating for maximum capacity and equipped with modules for the current requirements provides a high-performance response to scalability requirements.

DISTRIBUTION SYSTEM

The scalability of an electrical panel, via its distribution system, is indicated by the 3rd number in the Service Index (see below).

IS XXX

UPGRADING

Determines the capacity of the panel to respond to a future upgrade

1. Complete shutdown of the panel
2. Interruption limited to the functional unit concerned only. Spare functional units are provided
3. Addition of any type of functional unit in an unequipped location, without powering off the panel

→ **YES** Maintenance with no break in service and restart possible after 15 min

FORM OF THE FUNCTIONAL UNIT

Minimum IS required for the LV panel

MOBILITY INDEX
IS INDEX

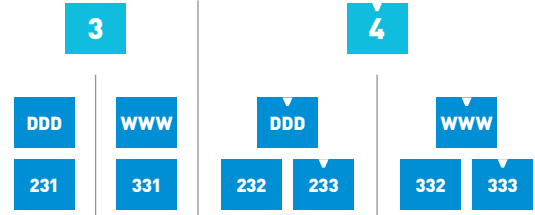

→ **YES** Maintenance with no break in service and restart possible after 1 hour

FORM OF THE FUNCTIONAL UNIT

Minimum IS required for the LV panel

MOBILITY INDEX
IS INDEX

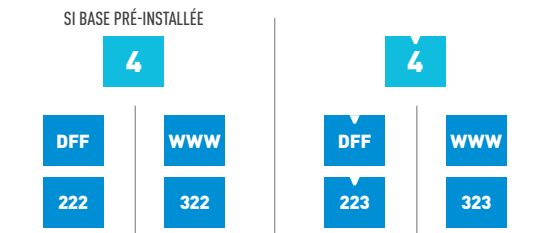

→ **NO** Maintenance with no break in service and restart possible after 1 hour

FORM OF THE FUNCTIONAL UNIT

Minimum IS required for the LV panel

MOBILITY INDEX
IS INDEX

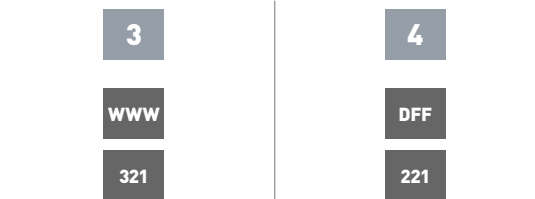

→ **NO** Implies complete power shutdown

FORM OF THE FUNCTIONAL UNIT

Minimum IS required for the LV panel

MOBILITY INDEX
IS INDEX

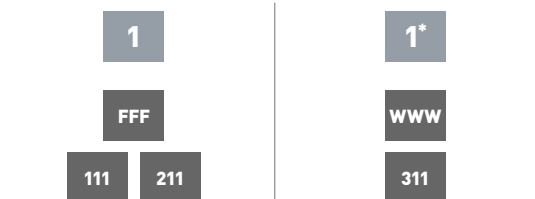

*No protection of live parts

SOLUTIONS RECOMMENDED BY LEGRAND

Increase capacity

Since IT equipment requirements change, the infrastructures must adapt to your requirements and allow upgrading without disturbing the operation of the existing installations.

Some systems incorporate this concept:

- using a particular technology (modular UPS system)
- by design (Cold Corridor®, PDU and structured cabling, electrical distribution in the computer room)
- by means of standards (eg: IS standard for distribution panels).

Scalability requirements in terms of capacity, resulting in increasing numbers of servers, concern 3 main areas:

■ Connectors

Various systems are necessary, from solutions pre-fitted with connectors to Hot Plug solutions for IT equipment, as well as high density and flexible electrical distribution.

■ Power

Increasing the capacity of a data center involves the installation of power solutions which combine adaptability and high performance both in terms of the architecture and their technical characteristics.

■ Cooling

Thermal high density solutions provide continuous cooling of the equipment!

NOTE

When adapting an infrastructure in order to increase a data center's capacities, it is essential to control capital expenditures (CAPEX), which can be substantial. This is possible by resorting to solutions which allow an evolution of capacities at the rate of the data center's real needs. Implemented in a modular design, these solutions will limit the engendered operating expenses (OPEX), all the while controlling scalability and availability.

CONNECTORS

■ Digital infrastructure

The LCS² system provides solutions with small copper and fibre optic cables pre-fitted with connectors.

So, for example, an RJ 45 copper LCS² link with 5.6 mm diameter cat 6_A STP cable gives a 20% reduction in the size of the ducts in comparison with a 7.2 mm diameter cable.

LCS² solutions can be installed at the top of the rack, by fixing on cable trays, which increases the flexibility of the installation and the server rack capacity.

To be noted: LCS² links, either with bare cables or cables pre-fitted with connectors, can perfectly be added in an installation equipped with the EZ-Path cable routing system. (for further information, see p. 61)

■ High Density (HD)

HD solutions allow upgrading because they are small. This ensures a high degree of availability of spaces for adding equipment in order to provide higher performance levels.

■ Electrical distribution for PDUs

This involves choosing the right electrical distribution mode for the PDUs.

For optimised distribution, Legrand recommends a BUSBAR solution with tap-off boxes, with or without metering. When it includes metering, this solution is ideal for colocation data centers. The complete unit, which can be connected to the power and to the metering bus while the installation is energised, provides maximum flexibility as its equipment is easy to adapt to the type of power supply required (three-phase/single phase, 16-32-63 A).

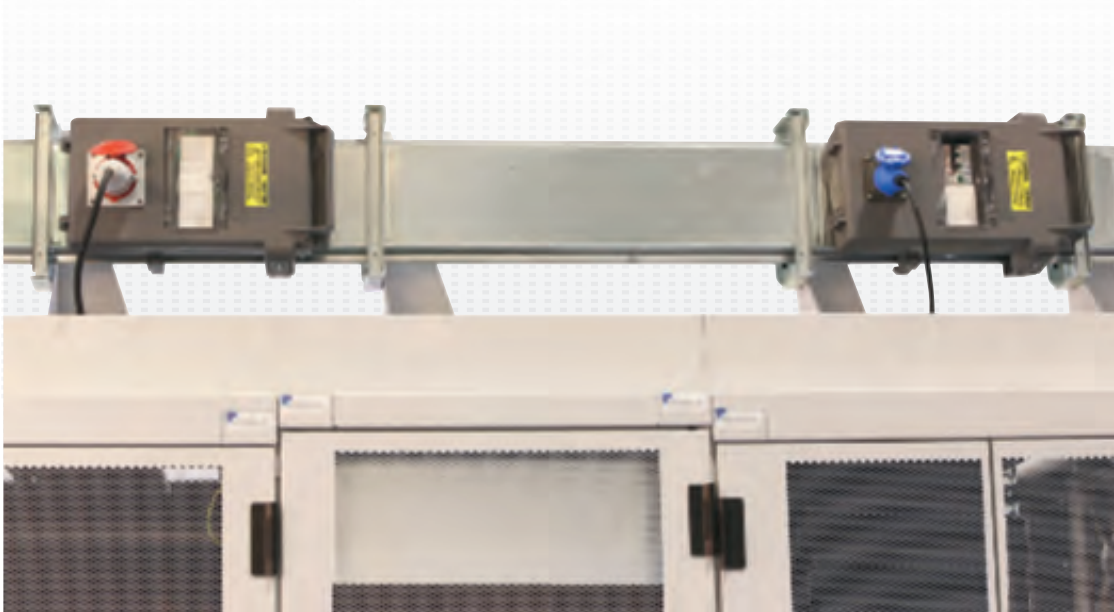

BUSBAR
equipped with
tap-off box

For small applications, Legrand offers Plug & Play solutions for cable routing and the IS 223 distribution panel. Offering good scalability at an optimum cost, this solution is ideal for enterprise data centers.

■ « Hot plug »

This system enables VDI equipment to be connected/disconnected while is energised, with no damage to the installation and with no break in service. (for further information, see p. 34)

POWER

■ **A modular architecture**

With the Legrand range of modular Uninterruptible Power Supplies it is possible to add power and battery modules, and thus to increase the capacity inside the UPS itself. Additional advantage: the connections upstream and downstream of the UPS are already made.

The Legrand range of parallelable UPS enables, together with IS optimised distribution solutions (HX³ range), an additional UPS to be added with no break in service, and provides for the necessary upstream and downstream connections.

With the KEOR HP solution, it is thus possible to connect up to six UPS in parallel to provide very high power capacities.

Note: the physical location of the UPS and some reserve space (unequipped space) must be provided in the electrical panel!

■ « Hot swap » system

Legrand UPS incorporate the Hot Swap function which enables UPS to be replaced/added while energised, with no damage to the installation and with no break in service. (for further information, see p. 38)



Archimod UPS with
« hot swap » system

■ **Physical upgrading of the white room**

Increasing the number of racks requires the addition of data and electrical connections. It also implies sufficient air conditioning power in the room.

COOLING

Thermal high density solutions provide continuous cooling of the equipment: the assurance of a high-performance building that can incorporate upgrades without any damage!

(for further information, see p. 10)

3 SCALABILITY | LEGRAND'S RESPONSE

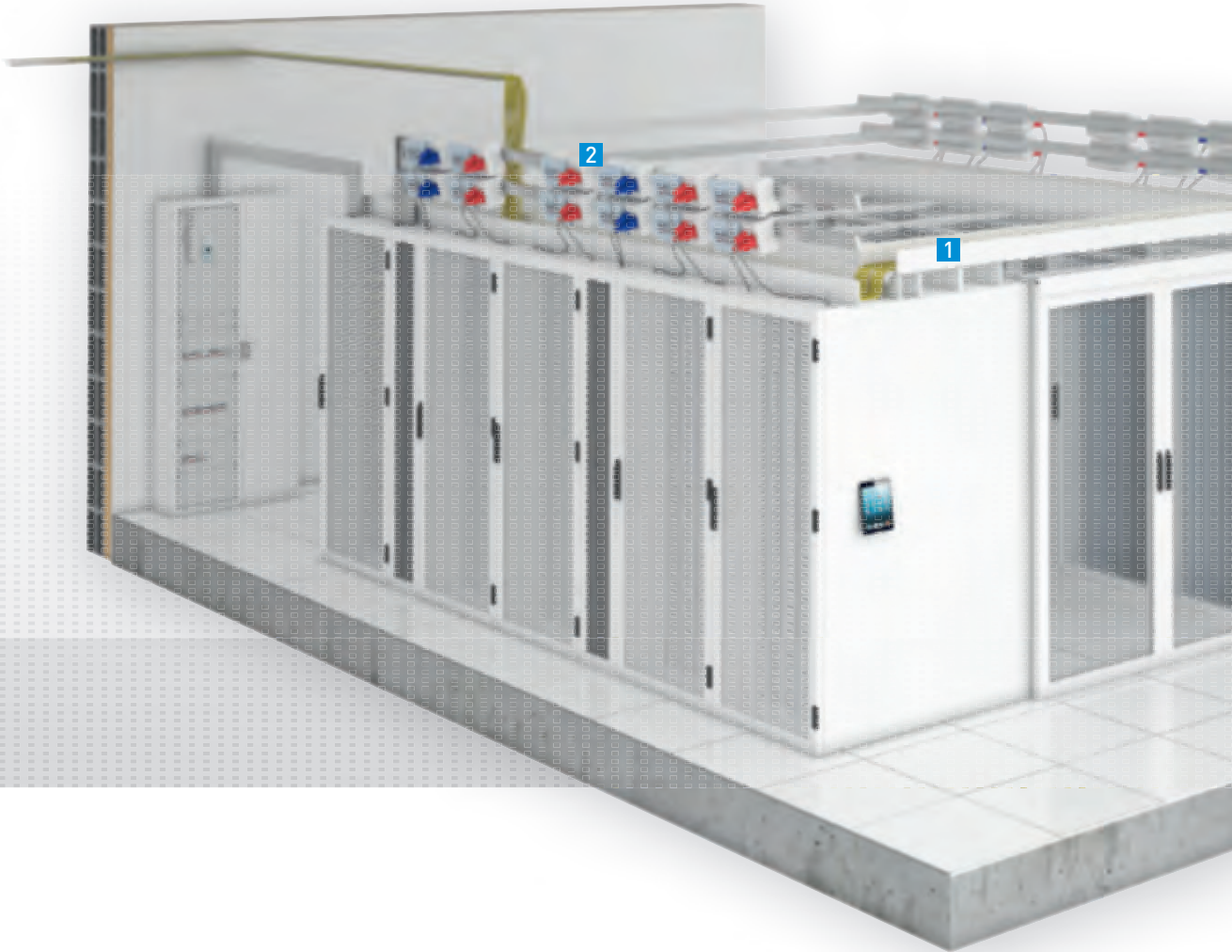

ENTERPRISE

PRODUCTS SOLUTIONS



1 Cable management
over Cold Corridor®
→ SEE P. 50



2 Tap-off box
over Cold Corridor®
→ SEE P. 51

h Safety

4 SAFETY AND SECURITY

OBJECTIVES:

- Protect against physical intrusion 58
- Protect against internal and external environmental events 60

Context & issues

As data centers house strategic data essential to the operation of the companies to which that data belongs, it is essential to ensure the data is protected. For this, two aspects must be considered.



EQUIPMENT

As data security is crucial for any data center owner (or for the owner's customers), increased protection of the equipment on which this data is located must be implemented.

PEOPLE

Since data centers cannot operate without human intervention, whether this is for maintenance or monitoring purposes, it is vital to ensure optimum safety and security for all workers/visitors who need to be on-site or in the data center.

NOTE

In 2010, approximately 10% of the budget for building a data center was allocated to safety and security of the building, with more than half of this being dedicated to fire detection and suppression.

Legrand's response

**OFFER SOLUTIONS
PROTECTING AGAINST:**

PHYSICAL INTRUSION
→ SEE P. 58

**INTERNAL AND EXTERNAL
ENVIRONMENTAL
EVENTS**
→ SEE P. 60

The protection requirements to ensure smooth operation of the data center and the safety and security of people working there are mainly connected with:

- physical intrusion: this involves preventing all unauthorised access, to ensure optimum protection of people and data.
- internal and external environmental events: whether these concern the internal infrastructure of the data center (overheating, fire, electrostatic discharge, water leaks, etc.) or its close proximity (fire, flood, lightning, earthquake, explosion, etc.), numerous risks must be prevented to ensure optimum safety and security of people and the building.



Protect against physical intrusion

For optimum protection of people and property against any physical intrusion, it must be possible to manage access control at various levels: at building, room, corridor, rack, etc. level.

To do so, Legrand can provide four main product families which ensure optimum safety and security of people and data.

CCTV

Legrand vandal-resistant IP cameras, which can be used both indoor and outdoor, provide optimum video surveillance due to their numerous advantages: compatibility with the ONVIF2 and PROFIL-S protocols enabling use with a global system, coverage of a large area, megapixel images, direct viewing/ action, traceability, etc.

For further information, see www.datacenter.legrand.com

IP dome camera



STANDARDS

Each data center is assigned a protection class according to its type, environment, the criticality of the data and the customers' requirements. This class defines the type of access that is authorised, as indicated in the following table:

TYPE OF PROTECTION	Class 1	Class 2	Class 3	Class 4
Protection against unauthorised access	Public or semi-public area	Area that is accessible to all authorized personnel (employees and visitors)	Area restricted to specified employees and visitors Other personnel with access to Protection Class 2 have to be accompanied by personnel authorized to access Protection Class 3 areas	Area restricted to specified employees Other personnel with access to Class 2 or 3 areas have to be accompanied by personnel authorized to access Class 4 areas

Source: standard EN 50600-1

NOTE

As the levels of requirements are very variable in colocation data centers, especially in a context in which the use of new technologies is playing an increasing important role, Legrand provides its expertise and support to help you select exactly the right solutions.



From badge and fingerprint readers for access control to supervision systems, Legrand offers you optimum solutions



ACCESS CONTROL

■ Access to the location

Badge and/or coded keypad systems, possibility of installation per room, compatibility with the WIEGAND protocol enabling combination with a third-party system: the range of centralised Legrand readers provides numerous functions to ensure a location is totally secure.

■ Access to the cabinet

For critical situations, it is highly advisable to use a locking system on each cabinet. Legrand cabinets with lockable doors provide the assurance of an electrical installation that is protected under all circumstances. These solutions include RFID badges, coded keypad and fingerprint systems.

For further information, see www.datacenter.legrand.com

SUPERVISION

Legrand CCTV and access control systems which have their own supervision tools can be integrated in third party software for overall management of the data center.

For further information, please consult us

CABLE ROUTING

Specially designed to meet the requirements of data centers, the P31 OFT (Optical Fibre Tray) range provides excellent technical performance levels and can be used for building complex installations using both optical fibre and copper. The rails and accessories provide a high degree of strength and excellent withstand to heavy loads.

Thus, with a wide range of totally closed cable trays, the Legrand cable routing solutions are particularly suitable for protecting cables, and therefore data.

For further information, see www.datacenter.legrand.com



Protect against Internal and external environmental events

The data center can be protected against internal environmental events (overheating, fire, electrostatic discharge, water leaks, etc.) and external environmental events (fire, flood, lightning, earthquake, explosion, etc.) both by installing detection solutions and by using products which ensure safety and reliability due to the way they operate or the way they have been manufactured.

This protection against internal and external environmental events can be managed at various levels: at building, room, corridor, rack, etc. level

STANDARDS

The class defines the level of protection applied:

TYPE OF PROTECTION	Class 1	Class 2	Class 3	Class 4
Protection against an internal fire	No special protection applied	Critical datacenter function is secured in case of events	Entire datacenter function is secured in case of events	Entire datacenter function is secured in case of events, even during the maintenance of the fire protection system
Protection against any other internal event or against an external event	No special protection applied	Mitigation applied	Mitigation applied	Mitigation applied

Source: standard EN 50600-1

In addition to the specific standards, it is also essential to comply with the safety standards for electrical installations (IEC 60364-X series of standards) for the selection and installation of equipment, the protection of people, and the safety and security of the installations.

Likewise, all live products (servers, switches, etc.) incorporated in the racks must comply with standard IEC 60950 on the safety of information technology equipment, to which reference must be made.

TECHNICAL DETECTION

Smoke, temperature rise, flood or water leak in air conditioning units, etc. are incidents which can have serious consequences on the operation of the data center. The comprehensive range of Legrand technical detectors, which can be used with sensors (optionally integrated), enables alarms to be raised quickly and a fast response.

For further information, see www.datacenter.legrand.com

NOTE

With the Legrand solutions, you can use a gateway to collect all the data received!

ELECTRICAL PROTECTION

Short-circuits, overloads, etc. are electrical events against which protection is provided by circuit breakers.

It is important to provide total discrimination between the various levels of protection and a very high level of selectivity.

■ Over voltage protection

To avoid equipment damage due to over-voltage, voltage surge protectors have to be installed in the electrical infrastructure (main switch board, tap-off box).

For further information, see www.datacenter.legrand.com

CABLE ROUTING

The EZ-PATH mechanical firestop caulking system provides optimum protection against fire spreading, whatever the load factor of the cables.

Because it enables cables to be added or removed without affecting its firestop performance, it is particularly suitable for infrastructures requiring modifications to the electric wiring, and ensures durable, flexible and sealed cable routing in installations.

For further information, see www.datacenter.legrand.com

POWER

The power devices are key components in a data center, and particular attention must be paid to their safety and security. It is essential to manage the risks concerning these devices, using:

■ Optimum manufacturing techniques

The manufacture of the insulating parts of Legrand transformers and capacitor banks using vacuum pressure moulding avoids any risk of fire breaking out, compared with manufacturing technologies using oil for cooling.

■ Optimisation of the electricity system

Management of the harmonics in UPS will, for example, provide a better quality system, for greater durability of the electrical infrastructure.

■ Capacitors in compensation systems

These do not contain oil or gas and have a triple safety system, comprising fuses and pressure monitoring devices. The materials used comply with standard UL94V2. This helps to limit the risks of fire as much as possible. The capacitor banks can also optionally be equipped with smoke detectors.

EZ-PATH mechanical firestop caulking system

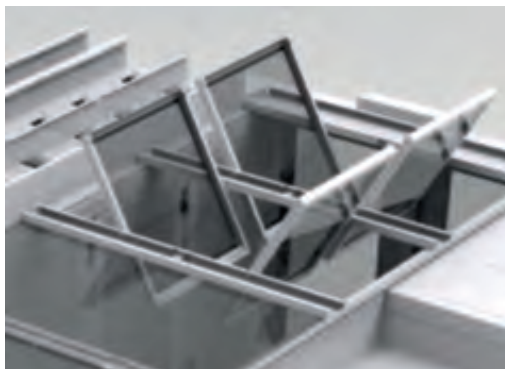
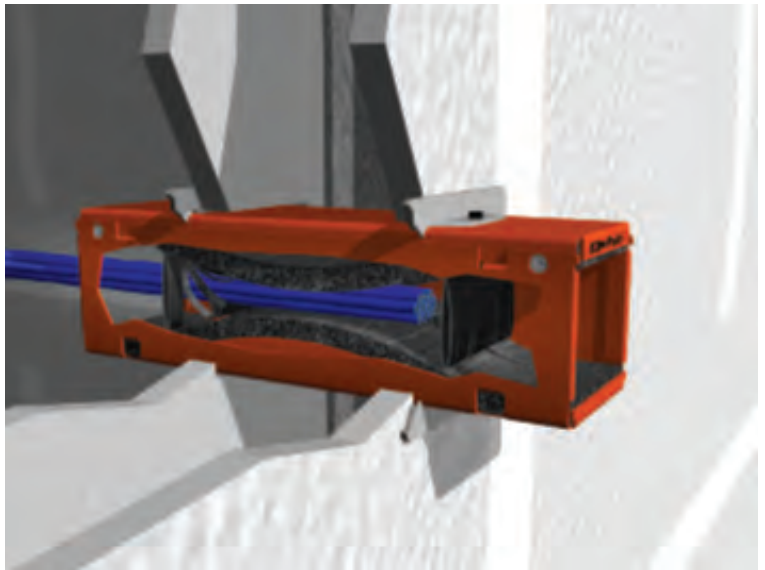

Pivot roof integrated with Cold Corridor

■ Optimised active losses and voltage level

Legrand solutions limit active losses in the cables, by taking account of the current carried in the installation, and improve the voltage level at the end of the line.

For further information, see www.datacenter.legrand.com

FIRE CONFINEMENT/ALARM

If a water fog or sprinkler fire suppression system is used in the white room in a containment situation, it is necessary to ensure suppression of the fire (in the event of an alarm) via an opening in the roof.

Legrand therefore incorporates an opening roof option (either automatic above 57°, or controlled electronically) in its Cold Corridor® solutions.

For further information, see www.datacenter.legrand.com

NOTE

Whatever the rating of the circuit breaker (from 2 A to 6300 A), the Legrand products confine the electric arc, limiting the risk of fire breaking out, with performance levels that comply in full with the standards. All this range can be used with auxiliaries for their supervision

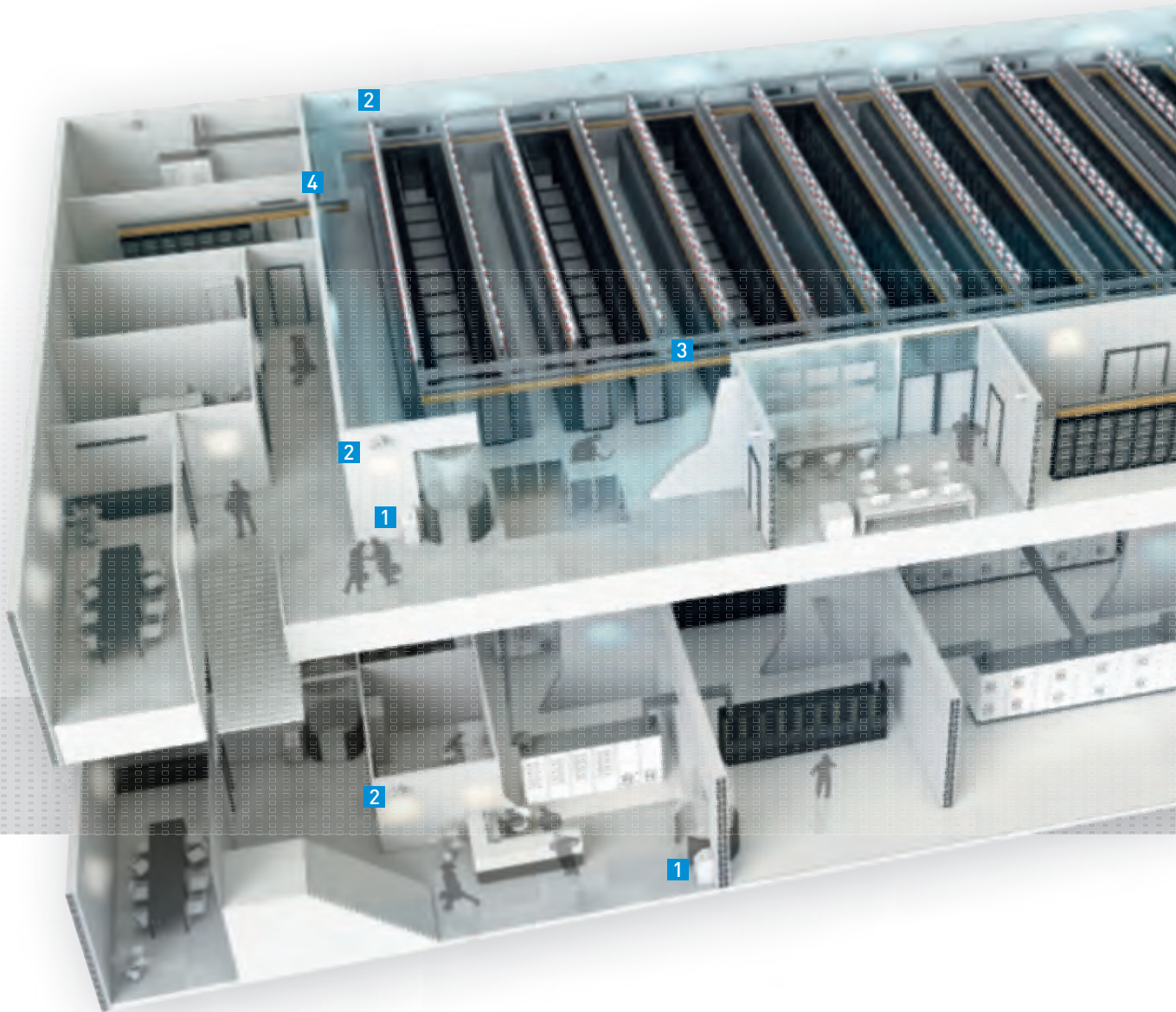

1 Biometric readers
→ SEE P. 59

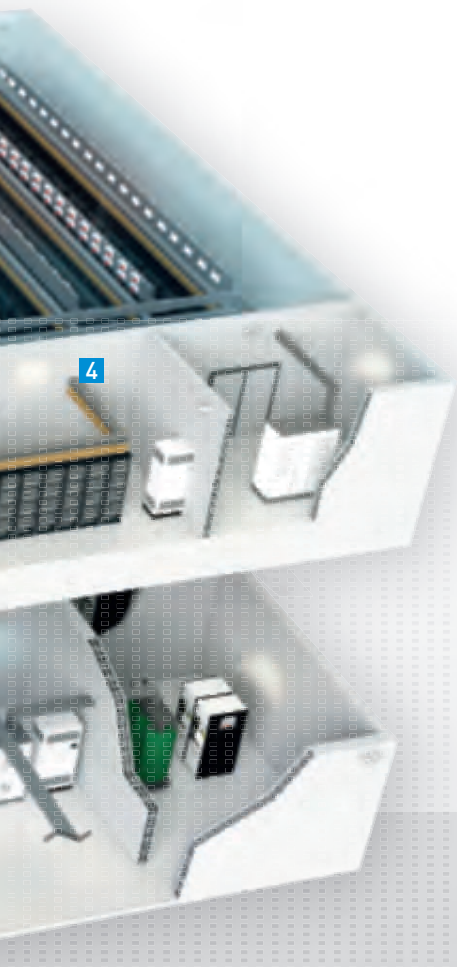

CORPORATE & COLOCATION

PRODUCTS SOLUTIONS



2 IP camera
→ SEE P. 58

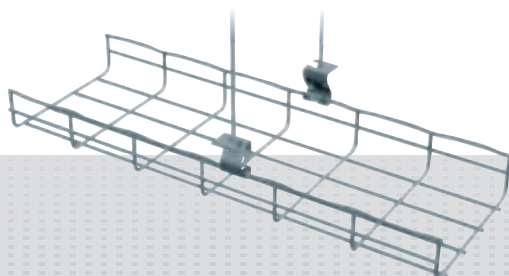

3 Cablofil
→ SEE P. 31

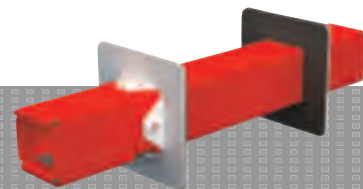

4 EZ-Path
→ SEE P. 61



**BEFORE
DEPLOYMENT**
OF YOUR PROJECT

- Design assistance / Tailored design studies
- Software
- Training
- Visits to reference sites / show-room
- Technical documents



**DURING
DEPLOYMENT**
OF YOUR PROJECT

- Assistance with implementation and commissioning according to products
- Training for operators
- Training and certification for installers
- Specific support for major projects



**IN
THE OPERATION**
OF YOUR PROJECT

- Diagnosis
- Installation maintenance service
- Software updates
- Warranty extension
- Training for operators and/or service providers

SUPPORTING YOU
EVERY STEP
OF THE WAY

GLOSSARY

Cloud computing

This is the use of remote servers that can be accessed via the Internet to process and store information.

Data center Enterprise

Small data center meeting the needs of small and medium sized companies whose business is simply supported by IT (universities, hospitals, town councils, etc.).

Data center Corporate

Medium to large data center, used by organisations whose core business is directly connected with the data center (banks, insurance companies, oil companies, etc.).

Data center Colocation

Large data center in which different entities can rent servers or space to install their own equipment.

Cold Corridor®

System enabling the cold air to be contained in corridors (server rooms) for optimised cooling and higher energy efficiency.

CRAC units

Computer Room Air Conditioning units.

Free cooling

Free cooling: the idea of free cooling is to cool a building using the difference in temperature between the air outside and the air inside the building. It can also be implemented using very cold water as a cooling source.

Green Grid

International consortium comprised of end-users, policy-makers, technology providers, facility architects, and utility companies, the Green Grid is committed to improving energy efficiency in data centers and, generally speaking, in business computing ecosystems.

In addition to the PUE, the Green Grid now proposes 4 other indicators to refine the assessment of the ecological footprint of a data center:

- the Green Energy Coefficient (GEC): this quantifies the proportion of renewable energy consumed by a data center
- the Energy Reuse Factor (ERF): this measures the amount of energy used outside the data center
- the Carbon Usage Effectiveness (CUE): this extrapolates a greenhouse gas emission volume based on the electricity consumption of the data center
- the Water Usage Effectiveness (WUE): this measures the amount of water used in the data center.

PUE

The PUE (Power Usage Effectiveness) is an indicator for measuring the energy efficiency of a data center by working out the following ratio: $PUE = \frac{\text{total consumption of the data center}}{\text{consumption of the computer and telecoms (IT) equipment}}$

Row-based cooling

This is a cooling solution installed in the corridor (between or in the cabinets) which allows for cooling as close as possible to the servers. There are two cooling technologies: direct expansion system (DX) and an ice water (H₂O) system.

DX system

Direct expansion system in which the coolant in the refrigerating machine circulates in the exchangers in contact with the internal air (evaporator) and the external air (air condenser). This is a closed circuit in which each indoor unit is associated with one outdoor unit.

H₂O system

This system, commonly called a chilled water system, uses water for exchanging thermal energy between the secondary system and the primary outdoor system. When the system is running outside a water/glycol mixture is used as a coolant to prevent freezing. The system can be designed as a single loop system avoiding an extra heat exchanger and therefore maximizing the capability of free cooling. The water infrastructure is commonly managed as a circuit for a whole room or is part of a complete building.

White room

Server room where the specific concentration is controlled in order to minimise the introduction, generation and retention of particles inside. Parameters such as temperature, humidity and relative pressure are maintained at a specific level.

Hot Plug

System enabling the connection/disconnection of devices under voltage, with no break in service.

Hot Swap

System enabling the replacement of devices under voltage, with no break in service.

IS XXX

French reference index for determining the type of distribution panel that will meet the requirements easily and precisely. It is rendered as a three digit code going from 1 to 3 which is used for operation, maintenance and upgrade.

Mobility Index

International benchmark that determines the design of the functional units in the panel, it is expressed as 3 letters F (fixed), D (disconnectable), W (withdrawable) which apply to the upstream power, downstream power and to the auxiliaries.

Tier classification

It's a standard methodology for defining the operating time of a data center. This is useful for measuring the performance of the DC availability, investment and ROI. The Tiers are split into 4 categories: Tier 1, Tier 2, Tier 3, Tier 4.

Green Transformers High Efficiency (GreenT.HE)

Green HV/LV Transformers High Efficiency.

PDU

Socket units generally inside a rack, allowing power to be supplied to the servers, often called Rack Distribution Units (RDU) in the USA. They can be basic, with a counter, supervised / with internal measurement.

STANDARDS

The reference standards in terms of availability principally relating to the structured wiring.

They include the planning and installation of the system as a whole as well as the technical characteristics of each component.

Even though they are structured differently depending on the continent, in each case they cover all the important topics and notably incorporate performance, security and installation compliance conditions.

INTERNATIONAL

The ISO/IEC 11801 standards specify the recommendations in terms of telecommunication wiring systems that apply both to copper and to fibre optic wiring.

Note: based on the definitions of wiring systems in ISO/IEC 11801, standard ISO/IEC 24764 provides additional specifications relating to data centers .

EUROPE

- Standards EN 50173

This series defines the design conditions of the structured symmetrical pair wiring systems in copper and in fibre optic in different installation locations which might comprise one or several buildings. It specifies the structure and the configuration of generic wiring, the performance specifications of the wiring, the implementation options for a wide range of Voice Data Image services, etc.

- Standard EN 50173-5 relates more specifically to data centres.

- Standards EN 50174

This series specifies the requirements relating to drawing up procedures and to documenting quality assurance associated with wiring for information technology, particularly for generic wiring systems designed in accordance with the EN 50173 series.

- Standard EN 50174-1 relates to quality assurance planning.
 - Standard EN 50174-2 relates to planning and installation practices inside buildings.
 - Standard EN 50174-3 relates to planning and installation practices outside buildings.
 - Standards TC215WG3 and EN 50-600
- This series specifies the particular arrangements for the infrastructure of a data center.

UNITED STATES

- Standards EIA/TIA 568-C

For the wiring performance.

This series, which superseded the previous series EIA/TIA 568-A and 568-B, specifies the minimum conditions for the wiring in individual commercial buildings or in complexes: physical, electrical and transmission requirements, maximum lengths that can be implemented, features of the components, etc.

- Standards EIA/TIA 942

For the installation design.

This series specifically defines wiring systems for data centres.



FOLLOW US ALSO ON

@ website: www.legrand.com

 www.youtube.com/legrand

 www.twitter.com/legrand



World Headquarters
and International Department
87045 Limoges Cedex - France
Tel. : + 33 (0) 5 55 06 87 87
Fax : + 33 (0) 5 55 06 74 55